



7º e 8º Etapas Copa Norte Paraná

6º ENDURO DE  
REGULARIDADE DE  
PAICANDU

PROVA: TRILHA  
DAS ÁGUAS

ATENÇÃO PILOTOS, REGIÃO  
CANAVIEIRA, TRÁFEGO DE  
CAMINHÕES NAS PRINCIPAIS.

Vistoria das 07:00hs as 07:45hs.

Intervalo para categorias  
MASTER será de 40 em 40  
Segundos DEMAIS CATEGORIA  
será de 20 em 20 segundos

- PRESERVE O VERDE E RESPEITE AS PROPRIEDADES ALHEIAS.
- TODAS AS ESTRADAS ESTÃO ABERTAS AO TRANSITO.

DESDE JA AGRADECEMOS  
A TODOS PILOTOS

	ATENÇÃO
	CUIDADO
	PERIGO

Tempo de Prova	
MAS / SEN	05:51:56
OVR / JUN	06:04:18
NOV / TUR	06:36:25



**AFERIÇÃO**





PADRÃO	
0,00	
0,27	
0,78	
1.125 AFERIÇÃO RETORNE!!!	
1,12	
<b>Início de Prova INICIO.</b>	
Deslocamento	
0,00	
0,02	
0,24	
0,35	
0,39	
<b>NO TRILHO</b>	

0,45	
0,00	
0,62	
1,15	
1,40	
1,91	
2,73	
0,00	
<b>GÁZZZZZ</b>	
0,04	
0,08	
0,24	
0,26	
0,39	
<b>BEIRE O MATO</b>	
0,47	

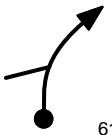
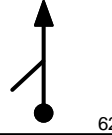

DOMINGO		4/50	
0,53			T4
0,63			T4
0,74			T4
0,92			T4
<b>SUBA GAZZZZ</b>			
0,99			T4
1,05		18 0.12.09 15 0.12.55 12 0.13.54 V T5	
1,16			T5
1,19			T5
1,23			T5
1,26			T5
<b>SUBA GAZZZZ</b>			
1,32			T5
1,40			T5
<b>Neutralizado</b>			
1,51		2' 0.13.41 1' 0.14.46 1' 0.16.12 N T6	

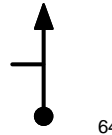
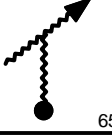
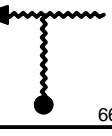
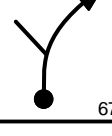
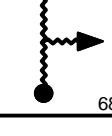
DOMINGO		5/50	
1,51		27 0.15.41 24 0.15.46 21 0.17.12 V T7	
1,64			T7
1,68			T7
1,84			T7
1,95		24 0.16.39 21 0.16.52 18 0.18.28 V T8	
2,05		21 0.16.54 18 0.17.09 15 0.18.48 V T9	
0,00			
0,02			T9
<b>M.M.S.</b>			
0,12			T9
<b>PONTE ESTREITA</b>			
0,18			T9
0,21			T9
0,25			T9
0,47			T9
0,58			T9

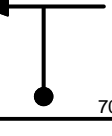
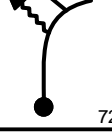
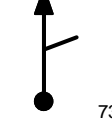
DOMINGO		6/50	
0,81			T9
<b>M.M.S.</b>			
0,84			T9
<b>PONTE ESTREITA</b>			
0,91			T9
0,94			T9
0,98			T9
1,04			T9
1,20			T9
1,25			T9
1,27			T9
1,34			T9
1,44			T9
1,49			T9
1,54			T9

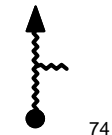
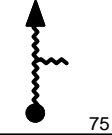
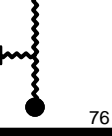
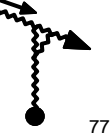
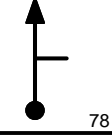
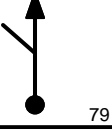
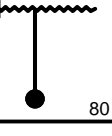
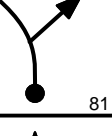
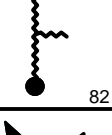
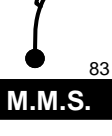
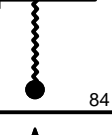
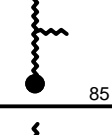
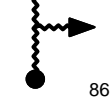
DOMINGO		7/50	
1,58		61	T9
1,61		62	T9
<b>M.M.S.</b>			
2,00		63	T9
2,05		64	T9
2,09		65	T9
2,11		66	T9
2,27		67	T9
2,29		68	T9
2,65		69	T9
<b>Neutralizado</b>			
2,84		70	T10
0,00	<b>N</b>	24 21 18	0.25.01 0.26.37 0.30.09
		V	T11
0,05		72	T11
0,13		73	T11

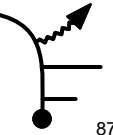
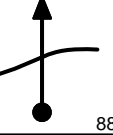
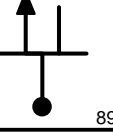
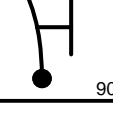
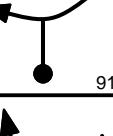
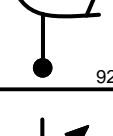
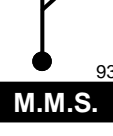
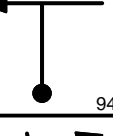

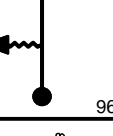
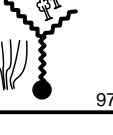
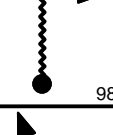
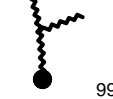
DOMINGO		8/50	
0,17		74	T11
0,29		75	T11
0,31		76	T11
<b>M.M.S.</b>			
0,35		77	T11
0,52		78	T11
0,58		79	T11
0,62		80	T11
0,79		81	T11
0,80		82	T11
0,99		83	T11
<b>M.M.S.</b>			
1,04		84	T11
1,26		85	T11
1,29		86	T11



DOMINGO		9/50	
1,36		87	T11
1,48		88	T11
1,74		89	T11
1,81		90	T11
1,98		91	T11
2,10		92	T11
2,14		93	T11
<b>M.M.S.</b>			
2,19		94	T11
2,24		95	T11
<b>DESÇA</b>			
2,29		96	T11
2,38		97	T11
2,42		98	T11
2,47		99	T11



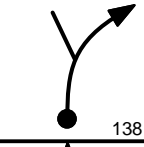
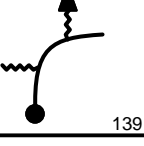
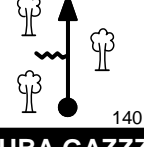
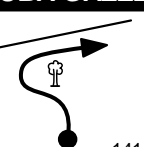
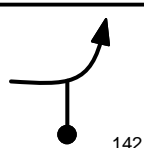
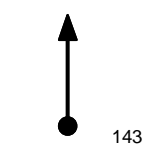

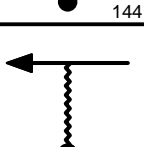
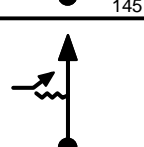
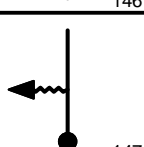
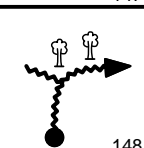
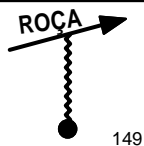
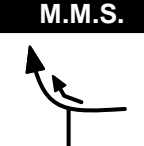
DOMINGO		10/50	
2,54			T11
2,56		51 0.33.25 48 0.34.56 45 0.39.41	T12
0,00		V	T12
0,15			T12
0,40			T12
0,73			T12
1,54			T12
1,59			T12
2,01			T12
<b>M.S.C.</b>			
2,12		21 0.35.55 18 0.37.35 15 0.42.31	T13
<b>TANTO FAZ</b>			
2,38			T13
<b>M.M.S.</b>			
2,65			T13
3,00			T13
<b>PL</b>			

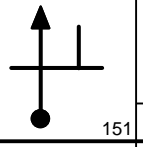
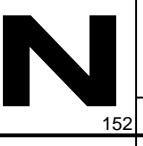
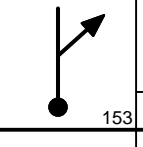
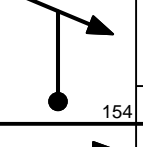
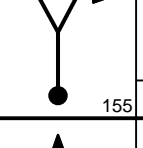
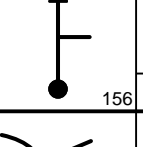
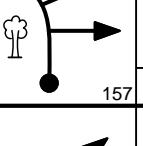
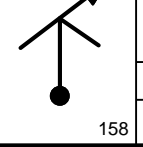
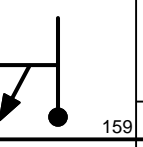
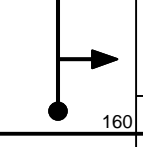
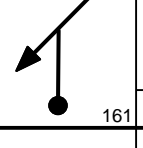
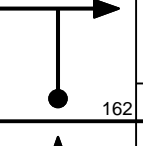
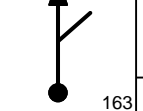

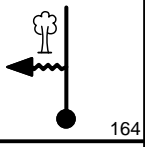
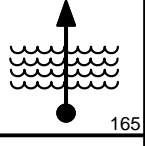
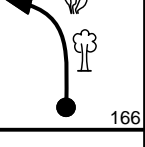
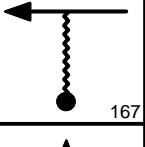
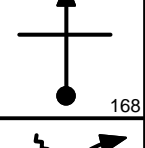
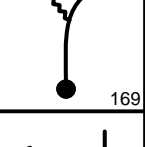

DOMINGO		11/50	
3,03		2' 0.38.31 1' 0.40.37 1' 0.46.09	T14
0,00	<b>N</b>	21 0.40.31 18 0.41.37 15 0.47.09	T15
0,09			T15
0,22			T15
0,32			T15
0,45			T15
0,48			T15
0,51			T15
1,12			T15
<b>M.M.S.</b>			
1,15		54 0.43.48 51 0.45.27 48 0.51.45	T16
1,29			T16
1,36			T16
1,49			T16

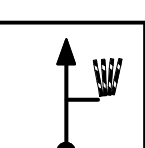
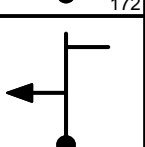
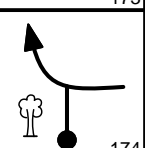

DOMINGO		12/50	
2,27			T16
2,98			T16
3,17			T16
3,39			T16
3,67			T16
3,70			T16
4,20			T16
<b>M.S.C.</b>			
4,33		21 0.47.20 18 0.49.11 15 0.55.44	T17
0,00		V	T17
0,26			T17
0,29			T17
0,65			T17
<b>PPL</b>			
0,67			T17
0,77			T17

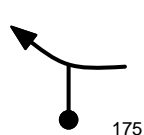
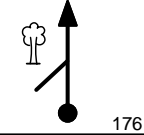
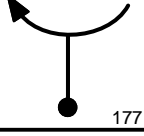
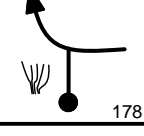
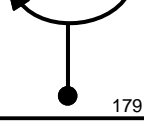
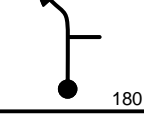
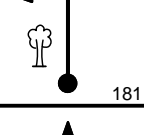
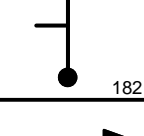
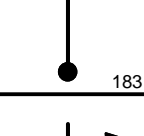

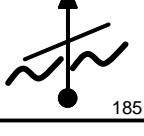
DOMINGO		13/50	
0,90		138	T17
1,13		18 0.50.34 15 0.52.57 12 1.00.15	V T18
1,19		140	T18
<b>SUBA GAZZZZ</b>			
1,21		141	T18
1,26		142	T18
1,43		143	T18
<b>SUBA GAZZZZ</b>			
1,51		144	T18
1,53		54 0.51.54 51 0.54.33 48 1.02.15	V T19
1,66		146	T19
1,79		18 0.52.11 15 0.54.52 12 1.02.35	V T20
1,82		148	T20
1,88		149	T20
<b>M.M.S.</b>			
1,95		150	T20
<b>Neutralizado</b>			

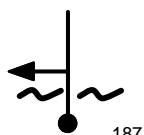
DOMINGO		14/50	
2,06		2' 0.53.05 1' 0.55.56 1' 1.03.56	N T21
2,06		54 0.55.05 51 0.56.56 48 1.04.56	V T22
2,51		153	T22
3,02		154	T22
3,34		155	T22
3,58		156	T22
4,46		157	T22
5,00		54 0.58.21 51 1.00.24 48 1.08.36	V T23
0,00		158	
0,12		159	T23
0,38		160	T23
0,93		161	T23
1,32		162	T23
1,40		163	T23

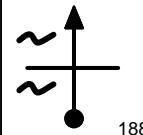
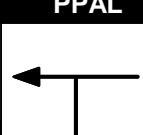
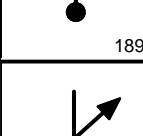
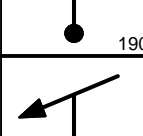
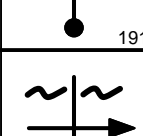
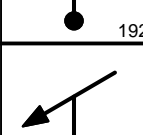
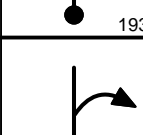
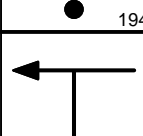
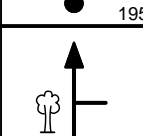
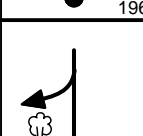
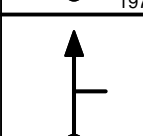
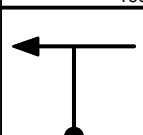
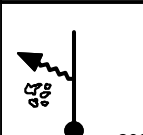
DOMINGO		15/50	
2,26		21 1.00.51 18 1.03.03 15 1.11.26	V T24
2,42		165	T24
2,47		166	T24
2,52		48 1.01.36 45 1.03.55 42 1.12.28	V T25
3,26		168	T25
3,58		169	T25
3,86		170	T25
<b>ABASTEÇA</b>			
<b>Neutralizado</b>			
4,11		10' 1.03.35 8' 1.06.03 7' 1.14.44	N T26
			
0,00		54 1.13.35 51 1.14.03 48 1.21.44	V T27
0,08		173	T27
0,70		174	T27

DOMINGO		16/50	
1,03		175	T27
1,31		176	T27
1,53		177	T27
1,66		178	T27
1,91		179	T27
2,32		180	T27
2,49		181	T27
2,54		182	T27
2,67		183	T27
2,69		39 1.16.35 36 1.17.12 33 1.25.06 V T28	
<b>CUIDADO VALETAS</b>			
3,62		185	T28
3,82		186	T28
<b>CUIDADO VALAS</b>			
4,16		187	T28

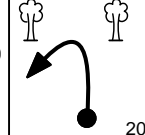
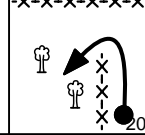
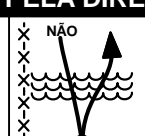

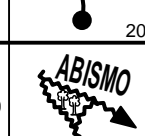
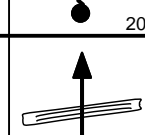
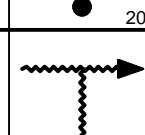
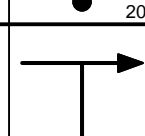
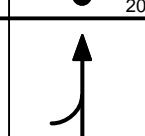
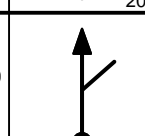
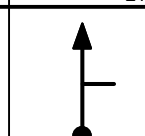
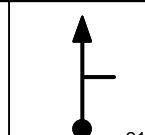
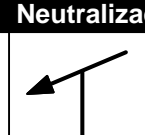



DOMINGO		17/50	
4,42		188	T28
<b>PPAL</b>			
4,92		45 1.20.00 42 1.20.55 39 1.29.09 V T29	
0,00		189	
0,03		190	T29
0,21		191	T29
0,49		192	T29
0,65		193	T29
1,06		194	T29
1,21		195	T29
1,24		196	T29
1,78		197	T29
2,57		198	T29
2,78		199	T29
2,93		15 1.23.55 12 1.25.07 9 1.33.40 V T30	

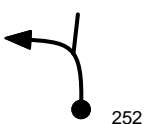
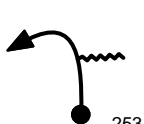
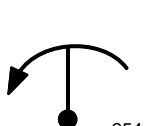
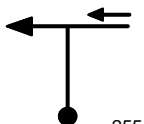
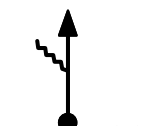
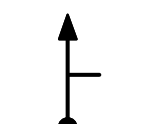
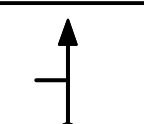

DOMINGO		18/50	
3,06		201	T30
3,17		202	T30
<b>PELA DIREITA</b>			
3,18		203	T30
<b>DESVIE ARVORE</b>			
3,23		204	T30
3,36		205	T30
3,38		206	T30
3,44		207	T30
3,68		208	T30
3,82		209	T30
3,96		210	T30
4,02		211	T30
4,22		212	T30
<b>Neutralizado</b>			
5,00		2' 1.32.12 1' 1.35.28 1' 1.47.28 N T31	

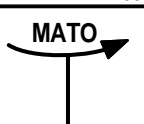
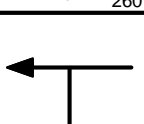

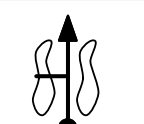
DOMINGO		19/50	
0,00	<b>N</b> 214	15 12 9	1.34.12 1.36.28 1.48.28
	<b>V</b>		<b>T32</b>
0,11	 215		<b>T32</b>
0,74	 216		<b>T32</b>
1,00	 217		<b>T32</b>
<b>ATT. EROSÕES</b>			
1,16	 218		<b>T32</b>
1,99	 219		<b>T32</b>
<b>ATT. VALA</b>			
2,20	 220	33 30 27	1.43.00 1.47.28 2.03.08
	<b>V</b>		<b>T33</b>
3,04	 221	45 42 39	1.44.31 1.49.08 2.05.00
	<b>V</b>		<b>T34</b>
3,17	 222		<b>T34</b>
3,41	 223		<b>T34</b>
<b>Deslocamento</b>			
3,49	 224	2' 2' 2'	1.45.07 1.49.47 2.05.41
	<b>D</b>		<b>T35</b>
<b>DESÇA E REZE</b>			
3,59	 225		<b>T35</b>
3,64	 226	21 18 15	1.47.07 1.51.47 2.07.41
	<b>V</b>		<b>T36</b>

DOMINGO		20/50	
<b>SUBA</b>			
3,69	 227		<b>T36</b>
<b>POR BAIXO</b>			
4,06	 228		<b>T36</b>
4,10	 229		<b>T36</b>
4,63	 230		<b>T36</b>
4,66	 231	36 33 30	1.50.02 1.55.11 2.11.46
	<b>V</b>		<b>T37</b>
5,31	 232		<b>T37</b>
6,04	 233		<b>T37</b>
6,66	 234		<b>T37</b>
6,68	 235	12 9 9	1.53.24 1.58.51 2.15.49
	<b>V</b>		<b>T38</b>
0,00	 236		<b>T38</b>
0,11	 237		<b>T38</b>
<b>CRUZE O RIO</b>			
0,12	 238		<b>T38</b>
<b>CRUZE O BREJO</b>			
0,27	 239		<b>T38</b>

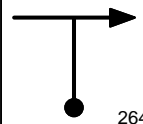
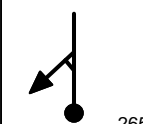
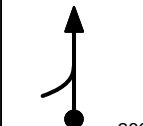
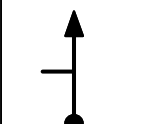
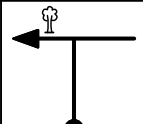
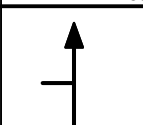
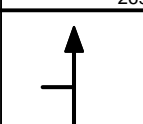
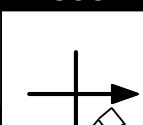
DOMINGO		21/50	
0,33	 240	27 24 21	1.55.03 2.01.03 2.18.01
	<b>V</b>		<b>T39</b>
0,96	 241		<b>T39</b>
1,56	 242		<b>T39</b>
1,65	 243	45 42 39	1.58.16 2.04.41 2.22.09
	<b>V</b>		<b>T40</b>
2,60	 244		<b>T40</b>
2,76	 245		<b>T40</b>
2,96	 246		<b>T40</b>
3,06	 247		<b>T40</b>
<b>M.M.S.</b>			
3,39	 248		<b>T40</b>
3,43	 249	21 18 15	2.00.28 2.07.02 2.24.41
	<b>V</b>		<b>T41</b>
<b>CUIDADO</b>			
0,07	 250		<b>T41</b>
0,63	 251		<b>T41</b>

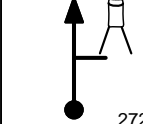
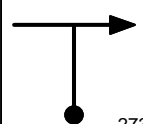
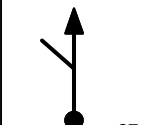
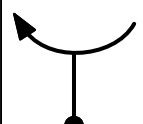
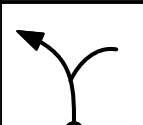
DOMINGO		22/50	
0,67		252	T41
1,10		253	T41
1,83		45 2.05.42 42 2.13.08 39 2.32.01	V T42
<b>M.M.S.</b>			
2,70		255	T42
2,74		256	T42
3,01		257	T42
3,16		258	T42
<b>CAUIDADO!!!</b>			
3,28		259	T42
3,68		260	T42
4,08		18 2.08.42 15 2.16.21 12 2.35.28	V T43
0,00		261	
<b>CDD EROSÃO!!!</b>			
0,21		262	T43
<b>CDD EROSÃO</b>			
0,27		263	T43

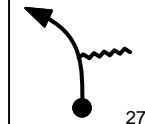
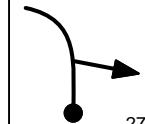
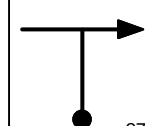
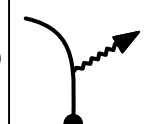
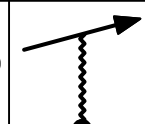
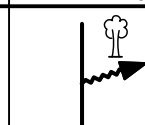
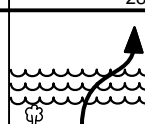
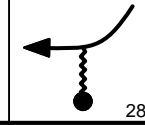
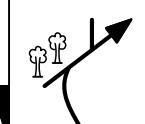
DOMINGO		23/50	
0,33		54 2.09.48 51 2.17.40 48 2.37.07	V T44
0,60		265	T44
1,23		266	T44
1,55		267	T44
2,03		268	T44
2,26		269	T44
2,86		270	T44
<b>ESCOLA</b>			
3,21		51 2.13.00 48 2.21.04 45 2.40.43	V T45
0,00		271	
0,59		272	T45
1,52		273	T45
1,63		274	T45
2,07		275	T45
2,29		276	T45

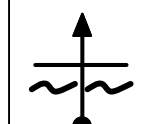
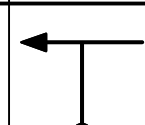
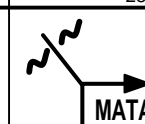
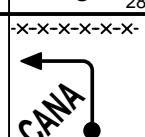
DOMINGO		24/50	
2,39		277	T45
2,64		278	T45
2,73		279	T45
2,76		280	T45
2,96		281	T45
3,07		24 2.16.37 21 2.24.54 18 2.44.49	V T46
3,14		283	T46
3,19		54 2.16.55 51 2.25.14 48 2.45.13	V T47
4,07		51 2.17.54 48 2.26.17 45 2.46.19	V T48
0,00		285	
<b>VALAS</b>			
0,42		286	T48
1,00		287	T48
1,23		288	T48
1,39		27 2.19.32 24 2.28.01 21 2.48.10	V T49



DOMINGO		25/50	
1,42		290	T49
1,66		291	T49
1,73		292	T49
1,91		293	T49
<b>PPAL</b>			
1,93		57	2.20.44
		54	2.29.22
		51	2.49.43
		V	T50
3,07		295	T50
3,97		296	T50
4,09		297	T50
4,56		39	2.23.30
		36	2.32.17
		33	2.52.48
		V	T51
5,74		57	2.25.19
		54	2.34.15
		51	2.54.57
		V	T52
0,00		299	
0,54		300	T52
2,24		301	T52
3,11		302	T52
<b>Deslocamento</b>			





DOMINGO		26/50	
3,92		1'	2.29.26
		1'	2.38.36
		1'	2.59.34
		D	T53
<b>Deslocamento</b>			
4,50		9'	2.30.26
		9'	2.39.36
		9'	3.00.34
		D	T54
0,00		304	
0,25		305	T54
0,46		306	T54
<b>ATENÇÃO</b>			
1,22			
			T54
1,79		308	T54
<b>Neutralizado</b>			
1,86		30'	2.39.26
		25'	2.48.36
		20'	3.09.34
		N	T55
<b>TOTEM</b>			
<i>v.5.32</i>			
<b>Deslocamento</b>			
0,00		5'	3.09.26
		5'	3.13.36
		5'	3.29.34
		D	T56
0,02		311	T56
0,24		312	T56
0,35		313	T56



DOMINGO		27/50	
0,40		314	T56
<b>NO TRILHO</b>			
0,45		33	3.14.26
		30	3.18.36
		27	3.34.34
		V	T57
<b>NO POSTE</b>			
1,07		316	T57
1,60		317	T57
2,15		318	T57
<b>CUIDADO</b>			
2,88			
			T57
3,00		320	T57
3,26		321	T57
3,55		322	T57
4,01		323	T57
4,08		324	T57
4,22		325	T57

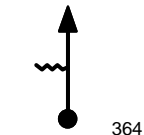
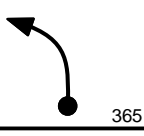
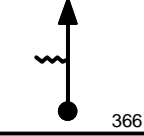

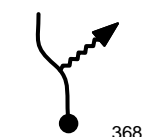
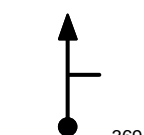
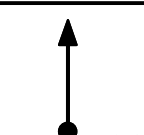
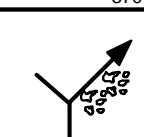
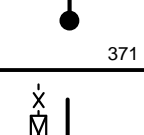
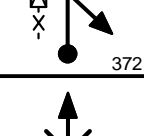
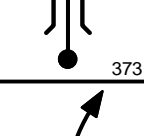
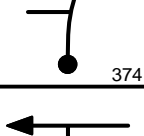
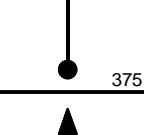
DOMINGO		28/50	
4,23		45 3.21.19	
0,00		42 3.26.10	
		39 3.42.58	
		V T58	
1,20			
			T58
1,28			
			T58
1,40			
			T58
1,42			
			T58
1,46			
			T58
1,54			
			T58
1,92			
			T58
1,99			
			T58
2,05			
			T58
2,07			
			T58
2,14			
			T58
2,16			
			T58

DOMINGO		29/50	
2,29			
		339	T58
2,31			
		340	T58
2,62			
		341	T58
2,67			
		342	T58
M.S.C. "POSSIVEL"			
3,22		12 3.25.36	
		9 3.30.46	
		9 3.47.55	
		V T59	
M.S.C.			
3,53			
		344	T59
M.S.C.			
3,75			
		345	T59
M.S.C.			
3,93		51 3.29.09	
		48 3.35.30	
		45 3.52.39	
0,00		V T60	
		346	
0,97			
		347	T60
M.M.S.			
1,80			
		348	T60
M.M.S.			
2,23			
		349	T60
2,36			
		350	T60

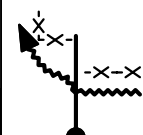
DOMINGO		30/50	
2,62			
		351	T60
3,07			
		352	T60
3,37			
		353	T60
3,74			
		354	T60
4,07			
		355	T60
4,46			
		356	T60
PPAL			
5,60		33 3.35.45	
		30 3.42.30	
		27 4.00.07	
		V T61	
Neutralizado			
5,91		2' 3.36.18	
		1' 3.43.07	
		1' 4.00.48	
		N T62	
0,00		33 3.38.18	
		30 3.44.07	
		27 4.01.48	
		V T63	
SUBA			
0,19			
		360	T63
0,27			
		361	T63
0,30			
		362	T63
BURACO			
0,69			
		363	T63

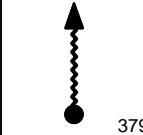
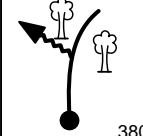
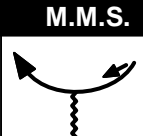
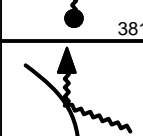
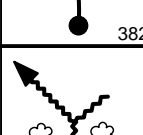
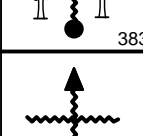
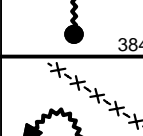
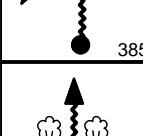
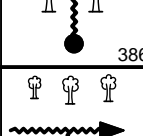
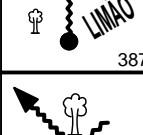
DOMINGO		31/50	
1,21			
		364	T63
<b>SUBA, GAZZZZ!!!</b>			
1,72			
		365	T63
2,12			
		366	T63
2,28			
		367	T63
2,30		45 3.42.29 42 3.48.43 39 4.06.55	
		368	V T64
3,36			
		369	T64
4,00			
		370	T64
4,54		45 3.45.28 42 3.51.55 39 4.10.22	
		371	V T65
0,00			
1,26			
		372	T65
2,17		15 3.48.22 12 3.55.01 9 4.13.42	
		373	V T66
2,21			
		374	T66
2,80			
		375	T66
3,20			
		376	T66

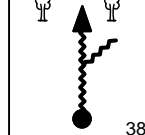
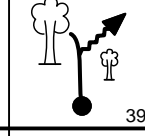
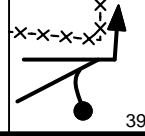
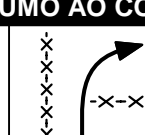
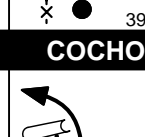
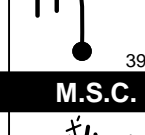

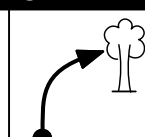
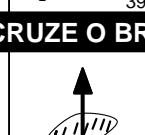
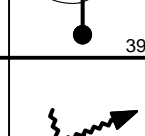
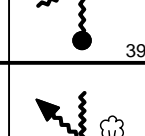
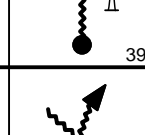

DOMINGO		32/50	
3,53		18 3.53.48 15 4.01.49 12 4.22.46	
		V	T67
0,00			
		377	
<b>NO MATO</b>			
0,14			
		378	T67
<b>RUMO ARVORE CAÍDA</b>			
0,30			
		379	T67
0,38			
		380	T67
<b>M.M.S.</b>			
0,40		30 3.55.08 27 4.03.25 24 4.24.46	
		V	T68
0,55		18 3.55.26 15 4.03.45 12 4.25.08	
		382	V T69
0,58			
		383	T69
0,61			
		384	T69
0,63		21 3.55.42 18 4.04.04 15 4.25.32	
		385	V T70
0,65			
		386	T70
0,67			
		387	T70
0,68			
		388	T70
<b>ATÉ O PÉ DE MANGA</b>			



DOMINGO		33/50	
0,82			
		389	T70
<b>MANGA NA SOMBRA</b>			
0,85			
		390	T70
0,90			
		391	T70
<b>RUMO AO COCHO</b>			
1,05			
		392	T70
<b>COCHO</b>			
1,09		15 3.57.01 12 4.05.36 9 4.27.23	
		393	V T71
<b>M.S.C.</b>			
1,15		21 3.57.16 18 4.05.54 15 4.27.47	
		394	V T72
<b>RUMO PÉ DE MANGA</b>			
1,17			
		395	T72
<b>CRUZE O BREJO</b>			
1,23			
		396	T72
1,25			
		397	T72
1,28			
		398	T72
1,33			
		399	T72
1,36			
		400	T72

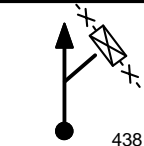
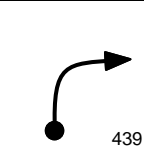
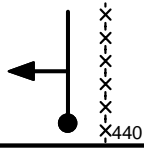
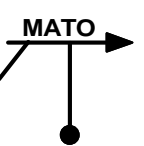
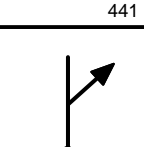

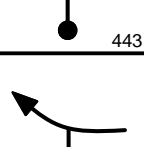
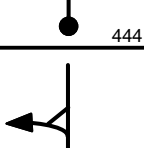
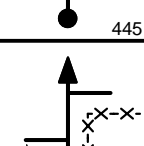
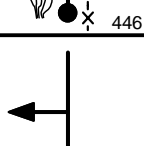
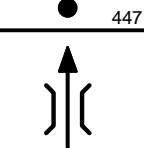
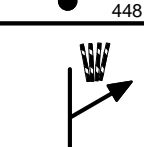
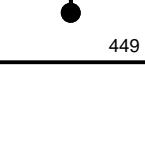

DOMINGO		34/50	
1,47		401	T72
1,57		402	T72
1,62		403	T72
1,69		404	T72
1,71		405	T72
1,79		406	T72
1,85		407	T72
<b>TOCO SALTE</b>			
1,87		408	T72
1,92		409	T72
1,97		410	T72
1,99		411	T72
<b>P/ ABANDONADA</b>			
2,08		412	T72
2,15		413	T72

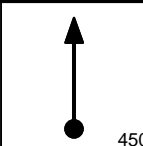
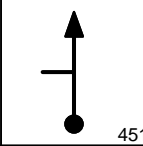
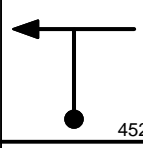
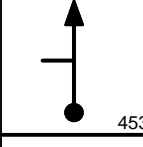
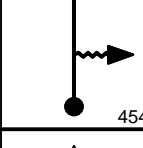
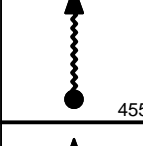
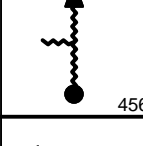
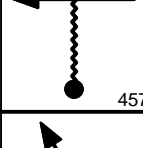
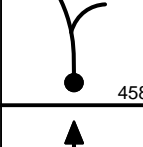
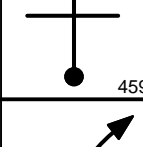
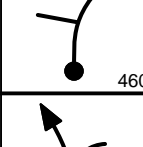
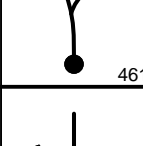
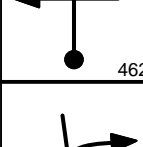
DOMINGO		35/50	
2,17		414	T72
<b>SUBA, GAZZZZ</b>			
2,23		415	T72
2,30		416	V T73
2,33		417	T73
2,40		418	T73
<b>BEIRE A CERCA</b>			
2,47		419	T73
2,91		420	T73
<b>NO TRILHO</b>			
3,11		421	T73
<b>CONTORNE O CURRAL</b>			
3,25		422	T73
3,31		423	T73
<b>Neutralizado</b>			
3,33		424	N T74
0,00		425	V T75

DOMINGO		36/50	
0,19		426	T75
0,44		427	T75
1,14		428	T75
<b>DESÇA C/ CUIDADO</b>			
1,61		429	D T76
1,61		1' 4.08.16	
		1' 4.16.59	
		1' 4.39.17	
<b>M.S.C.</b>			
1,62		430	T76
1,74		431	V T77
1,74		15 4.09.16	
		12 4.17.59	
		9 4.40.17	
<b>DESÇA C/ CUIDADO</b>			
1,78		432	V T78
1,78		18 4.09.26	
		15 4.18.11	
		12 4.40.33	
<b>LAGE</b>			
3,55		433	T78
<b>M.S.C.</b>			
3,93		434	D T79
3,93		1' 4.16.36	
		1' 4.26.47	
		1' 4.51.18	
<b>PRINCIPAL</b>			
3,97		435	N T80
3,97		5' 4.17.36	
		3' 4.27.47	
		2' 4.52.18	
0,00		436	V T81
0,00		51 4.22.36	
		48 4.30.47	
		45 4.54.18	
0,92		437	T81

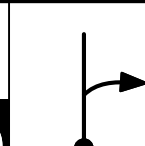
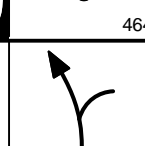
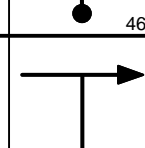
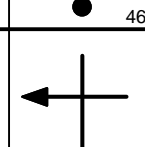
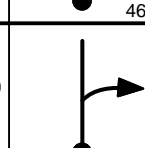
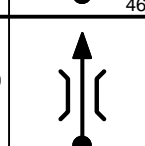
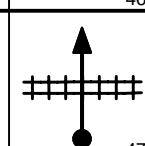
DOMINGO		37/50	
1,62		39 4.24.30 36 4.32.48 33 4.56.28	V T82
<b>CURVA PERIGOSA</b>			
2,38		45 4.25.40 42 4.34.04 39 4.57.51	V T83
3,73			T83
4,69		45 4.28.45 42 4.37.22 39 5.01.24	V T84
0,00			T84
0,39			T84
<b>SALTOS</b>			
0,45			T84
0,62			T84
1,40			T84
2,38			T84
2,65			T84
2,68		42 4.32.24 39 4.41.17 36 5.05.37	V T85
2,74			T85
0,00			T85

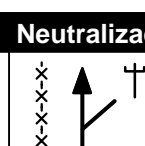

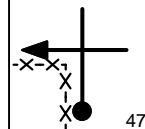



DOMINGO		38/50	
0,50			T85
0,67			T85
2,25			T85
2,72			T85
2,95			T85
3,25			T85
3,50			T85
3,51		45 4.37.25 42 4.46.41 39 5.11.28	V T86
3,67			T86
4,14			T86
4,34			T86
4,77			T86
5,13			T86
5,53			T86



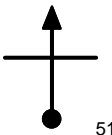

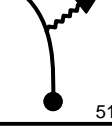
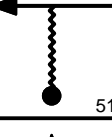
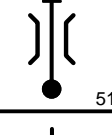
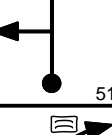
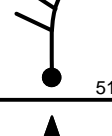
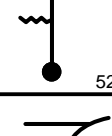

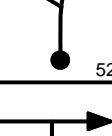
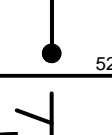
DOMINGO		39/50	
5,95		45 4.40.40 42 4.50.10 39 5.15.13	V T87
0,00			T87
1,43			T87
1,93			T87
2,07			T87
3,06			T87
4,16		21 4.46.13 18 4.56.07 15 5.21.37	V T88
4,71			T88
<b>ABASTEÇA</b>			
<b>Neutralizado</b>			
4,73		10' 4.47.51 8' 4.58.01 7' 5.23.54	N T89
			
0,00	<b>N</b>	54 4.57.51 51 5.06.01 48 5.30.54	V T90
0,03			T90



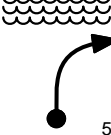

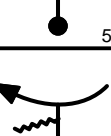
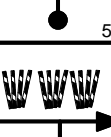

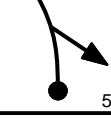
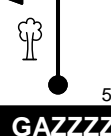
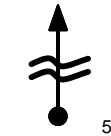
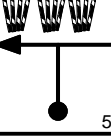
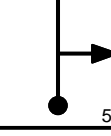
DOMINGO		40/50	
0,24		474	T90
0,43		475	T90
0,57		476	T90
1,71		477	T90
2,42		478	T90
<b>BEIRE O TRILHO</b>			
2,61		479	T90
4,35		54 5.02.41 51 5.11.08 48 5.36.20 V T91	
0,00		480	
1,50		481	T91
<b>PPAL</b>			
2,00		482	T91
2,56		483	T91
2,66		484	T91
4,32		485	T91
5,21		18 5.08.28 15 5.17.16 12 5.42.51 V T92	

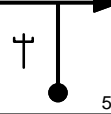
DOMINGO		41/50	
5,24		18 5.08.34 15 5.17.23 12 5.43.00 V T93	
0,00		487	
0,11		488	T93
0,19		489	T93
0,24		490	T93
0,25		491	T93
0,27		492	T93
<b>DESCA C/ CUIDADO</b>			
0,53		493	T93
0,55		494	T93
<b>CUIDADO CHIFRE</b>			
0,63		495	T93
0,80		496	T93
<b>TOCO</b>			
0,90		497	T93
0,92		498	T93

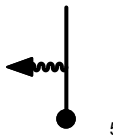
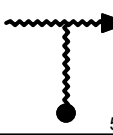
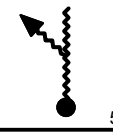
DOMINGO		42/50	
0,93		499	T93
1,09		500	T93
1,15		501	T93
1,24		502	T93
1,37		54 5.13.08 51 5.22.52 48 5.49.51 V T94	
1,63		504	T94
2,25		30 5.14.07 27 5.23.54 24 5.50.57 V T95	
3,03		506	T95
3,04		54 5.15.42 51 5.25.39 48 5.52.56 V T96	
4,37		508	T96
4,53		509	T96
<b>Neutralizado</b>			
4,76		2' 5.17.36 1' 5.27.41 1' 5.55.05 N T97	
0,00		54 5.19.36 51 5.28.41 48 5.56.05 V T98	

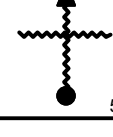
DOMINGO		43/50	
0,16		512	T98
1,05		513	T98
1,22		514	T98
2,31		515	T98
2,67		516	T98
2,70		33 5.22.36 30 5.31.51 27 5.59.27 V	T99
2,91		518	T99
2,96		519	T99
3,29		520	T99
3,43		521	T99
3,55		522	T99
3,61		523	T99
3,66		524	T99
<b>RIO</b>			

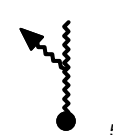
DOMINGO		44/50	
3,82		525	T99
<b>SUBA, GAZZZZ, SALTOS</b>			
3,86		526	T99
<b>GAZZZZ</b>			
3,93		527	T99
3,96		528	T99
4,00		33 5.24.58 30 5.34.27 27 6.02.21 V	T100
0,00		529	T100
<b>PEDREIRA</b>			
0,06		530	T100
0,08		531	T100
<b>GAZZZZ</b>			
0,13		532	T100
0,20		533	T100
0,29		534	T100
0,61		535	T100
0,78		536	T100

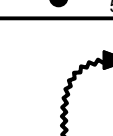
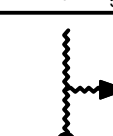
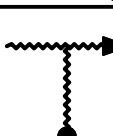
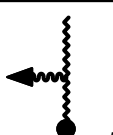
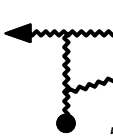
DOMINGO		45/50	
1,18		18 5.27.07 15 5.36.49 12 6.04.58 V	T101
1,23		538	T101
1,41		539	T101
1,70		540	T101
1,71		541	T101
1,73		542	T101
<b>GAZZZZ</b>			
1,81		543	T101
<b>GAZZZZ</b>			
1,86		544	T101
1,93		545	T101
1,98		546	T101
2,02		547	T101
2,04		548	T101
2,08		549	T101
<b>GAZZZZ</b>			

DOMINGO		46/50	
2,30		550	T101
<b>GAZZZZZ</b>			
2,32		551	T101
2,40		552	T101
2,47		553	T101
2,52		554	T101
2,61		555	T101
2,65		556	T101
2,66		557	T101
2,73		558	T101
2,83		559	T102
<b>0,00</b>			
0,12		560	T102
0,16		561	T102
0,32		562	T102

DOMINGO		47/50	
0,49		563	T102
0,60		564	T102
<b>DESÇA C/ CUIDADO</b>			
0,62		565	T102
0,67		566	T102
0,74		567	T102
0,77		568	T102
0,80		569	T102
0,86		570	T102
0,87		571	T102
0,98		572	T102
1,00		573	T102
<b>VALA CUIDADO</b>			
1,10		574	T102
1,11		575	T102

DOMINGO		48/50	
1,12		576	T102
1,13		577	T102
1,17		578	T102
<b>M.M.S.</b>			
1,19		579	T102
1,21		580	T102
1,25		581	T102
1,28		582	T102
1,46		583	T102
1,55		584	T102
1,72		585	T102
1,80		586	T102
1,92		587	T102
1,94		588	T102



2,13		45	5.39.43
		42	5.51.56
		39	6.23.52
		V	<b>T103</b>

2,20			
			T103

3,02			
			T103

3,53			
			T103

**Deslocamento**

3,79		10'	5.41.56
		10'	5.54.18
		10'	6.26.25
		D	<b>T104</b>

0,00			
------	--	--	--

0,42			
			T104

0,89			
			T104

**ATENÇÃO**

1,63			
			T104

**BUEIRO**

2,26		0'	5.51.56
		0'	6.04.18
		0'	6.36.25
		N	<b>T105</b>

**FIM DA PROVA !!**



Planilha gerada pelo programa TotemPlanilha que foi criado pela Totem.

ESTA É UMA DAS FORMAS QUE A TOTEM PARTICIPA DA EVOLUÇÃO DO OFF ROAD.

[WWW.TOTEMONLINE.COM.BR](http://WWW.TOTEMONLINE.COM.BR)

Planilha\_Paicandu.pla

ADCB5245B905

v5.32

**ESPERAMOS QUE TENHA GOSTADO!!!**

**OBRIGADO POR TER PARTICIPADO.**