

TRILHAS DO ALEMÃO		1/50
	<b>ATENÇÃO</b>	
	<b>CUIDADO</b>	
	<b>PERIGO</b>	
<b>Tempo de Prova</b>		
MAS / SEN	06:14:54	
JUN / OVR	06:24:05	
NOV / TUR	06:38:28	
<b>AFERIÇÃO</b> PIZZARIA BLACK BURGER		
0,00		F
Q.M.		
0,06		Afer
0,55		Afer
<b>AFERIR NO QUEBRA MOLA COM 1.310 KM</b>		
1,31		Afer
0,00		Afer

TRILHAS DO ALEMÃO		2/50
<b>PIZZARIA BLACK BURGER</b>		
1,31		Afer
<b>Início de Prova</b> <b>ZERE NA ÁRVORE</b>		
<b>Deslocamento</b>		
0,00		5' 0.00.00
		5' 0.00.00
		5' 0.00.00
		D
0,06		D1
0,55		D1
0,62		D1
0,93		D1
1,24		12 0.05.00
		12 0.05.00
		12 0.05.00
0,00		V V2
<b>NO BURACO</b>		
0,06		0.05.18
		0.05.18
		0.05.18
		V2
<b>GAZZZZ</b>		
0,08		0.05.24
		0.05.24
		0.05.24
		V2
0,11		0.05.33
		0.05.33
		0.05.33
		V2

TRILHAS DO ALEMÃO		3/50
<b>BANDEIRAS</b>		
0,15		0.05.45
		0.05.45
		0.05.45
		V2
0,22		0.06.06
		0.06.06
		0.06.06
		V2
<b>GAZZZ TOCO</b>		
0,33		0.06.39
		0.06.39
		0.06.39
		V2
0,35		0.06.45
		0.06.45
		0.06.45
		V2
0,44		0.07.12
		0.07.12
		0.07.12
		V2
0,54		0.07.42
		0.07.42
		0.07.42
		V2
<b>CURVA DE NIVEL</b>		
0,62		0.08.06
		0.08.06
		0.08.06
		V2
0,68		0.08.24
		0.08.24
		0.08.24
		V2
<b>CURVA DE NIVEL</b>		
0,74		0.08.42
		0.08.42
		0.08.42
		V2
0,81		0.09.03
		0.09.03
		0.09.03
		V2
0,91		0.09.33
		0.09.33
		0.09.33
		V2
<b>Deslocamento</b>		
1,00		3' 0.10.00
		3' 0.10.00
		3' 0.10.00
		D D3
0,00		

TRILHAS DO ALEMÃO		4/50	
0,07		28	D3
0,37		29	D3
0,41		12	0.13.00
0,00		12	0.13.00
		12	0.13.00
		V	V4
0,06		31	0.13.18 0.13.18 0.13.18 V4
0,10		32	0.13.30 0.13.30 0.13.30 V4
0,37		33	0.14.51 0.14.51 0.14.51 V4
0,41		34	0.15.03 0.15.03 0.15.03 V4
0,52		35	0.15.36 0.15.36 0.15.36 V4
0,62		36	0.16.06 0.16.06 0.16.06 V4
<b>GÁZZZZZ</b>			
0,72		37	0.16.36 0.16.36 0.16.36 V4
0,76		38	0.16.48 0.16.48 0.16.48 V4
<b>M.M.S.</b>			
0,85		39	0.17.15 0.17.15 0.17.15 V4
0,97		40	0.17.51 0.17.51 0.17.51 V4

TRILHAS DO ALEMÃO		5/50	
1,06		41	0.18.18 0.18.18 0.18.18 V4
<b>M.S.C.</b>			
<b>Deslocamento</b>			
1,09		42	2' 0.18.27 2' 0.18.27 2' 0.18.27 D
1,19		43	D5
1,28		44	12 0.20.27 12 0.20.27 12 0.20.27 V
1,32		45	0.20.39 0.20.39 0.20.39 V6
<b>Deslocamento</b>			
1,42		46	2' 0.21.09 2' 0.21.09 2' 0.21.09 D
1,53		47	D7
<b>NO POSTE</b>			
1,63		48	36 0.23.09 33 0.23.09 30 0.23.09 V V8
0,00		48	36 0.23.09 33 0.23.09 30 0.23.09 V V8
<b>Neutralizado</b>			
0,08		49	5' 0.23.17 4' 0.23.18 3' 0.23.19 N
0,08	<b>N</b>	50	36 0.28.17 33 0.27.18 30 0.26.19 V
0,76		51	0.29.25 0.28.32 0.27.40 V10

TRILHAS DO ALEMÃO		6/50	
0,89		52	0.29.38 0.28.46 0.27.56 V10
1,02		53	0.29.51 0.29.00 0.28.11 V10
1,10		54	0.29.59 0.29.09 0.28.21 V10
1,78		55	0.31.07 0.30.23 0.29.43 V10
2,00		56	0.31.29 0.30.47 0.30.09 V10
2,19		57	0.31.48 0.31.08 0.30.32 V10
2,78		58	0.32.47 0.32.12 0.31.43 V10
2,87		59	0.32.56 0.32.22 0.31.53 V10
3,11		60	0.33.20 0.32.48 0.32.22 V10
3,15		61	0.33.24 0.32.53 0.32.27 V10
3,23		62	0.33.32 0.33.01 0.32.37 V10
<b>CDD!!! RODOVIA</b>			
3,38		63	0.33.47 0.33.18 0.32.55 V10
3,47		64	0.33.56 0.33.28 0.33.05 V10



TRILHAS DO ALEMÃO		7/50
3,56		0.34.05 0.33.37 0.33.16 V10
3,60		0.34.09 0.33.42 0.33.21 V10
3,94		0.34.43 0.34.19 0.34.02 V10
4,01		0.34.50 0.34.26 0.34.10 V10
4,03		0.34.52 0.34.29 0.34.13 V10
4,11		0.35.00 0.34.37 0.34.22 V10
<b>CDD!!! RODOVIA</b>		
4,25		0.35.14 0.34.53 0.34.39 V10
4,34		0.35.23 0.35.02 0.34.50 V10
4,56		0.35.45 0.35.26 0.35.16 V10
4,64		0.35.53 0.35.35 0.35.26 V10
4,78		0.36.07 0.35.50 0.35.43 V10
4,87		0.36.16 0.36.00 0.35.53 V10
4,96		0.36.25 0.36.10 0.36.04 V10

TRILHAS DO ALEMÃO		8/50
5,01		0.36.30 0.36.16 0.36.10 V10
5,35		0.37.04 0.36.53 0.36.51 V10
5,63		36 0.37.32 33 0.37.23 30 0.37.25 V V11
0,00		
0,41		0.38.13 0.38.08 0.38.14 V11
1,08		0.39.20 0.39.21 0.39.34 V11
1,76		0.40.28 0.40.35 0.40.56 V11
1,88		0.40.40 0.40.48 0.41.10 V11
2,01		0.40.53 0.41.02 0.41.26 V11
2,10		0.41.02 0.41.12 0.41.37 V11
2,22		0.41.14 0.41.25 0.41.51 V11
<b>ÁRVORE CAÍDA</b>		
2,40		0.41.32 0.41.45 0.42.13 V11
2,91		0.42.23 0.42.41 0.43.14 V11
<b>RUMO AO ????????</b>		
3,07		0.42.39 0.42.58 0.43.33 V11

TRILHAS DO ALEMÃO		9/50
3,15		0.42.47 0.43.07 0.43.43 V11
<b>CDD!!! REPRESA</b>		
3,24		0.42.56 0.43.17 0.43.53 V11
3,36		0.43.08 0.43.30 0.44.08 V11
3,46		0.43.18 0.43.41 0.44.20 V11
3,56		0.43.28 0.43.52 0.44.32 V11
<b>FORA DA CANALETA</b>		
3,61		0.43.33 0.43.57 0.44.38 V11
3,71		0.43.43 0.44.08 0.44.50 V11
3,79		0.43.51 0.44.17 0.44.59 V11
3,91		0.44.03 0.44.30 0.45.14 V11
<b>Neutralizado</b>		
4,16		2' 0.44.28 1' 0.44.57 1' 0.45.44 N
0,00		45 0.46.28 42 0.45.57 39 0.46.44 V
0,87		0.47.38 0.47.12 0.48.04 V13
1,24		0.48.07 0.47.43 0.48.38 V13

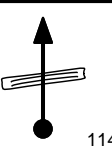
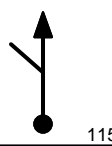
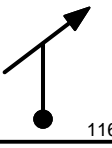
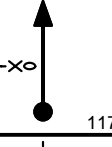
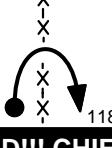
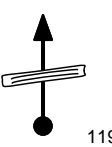
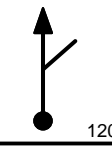
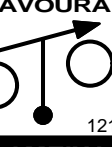
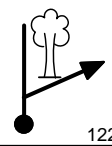
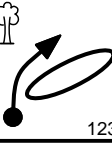
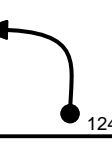
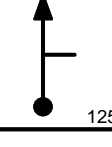
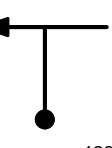
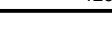
TRILHAS DO ALEMÃO		10/50	
1,54		0.48.31 0.48.09 0.49.06	V13
2,10		0.49.16 0.48.57 0.49.58	V13
<b>ARVORE CAIDA</b>			
2,26		0.49.29 0.49.11 0.50.12	V13
2,78		0.50.10 0.49.55 0.51.00	V13
2,90		0.50.20 0.50.06 0.51.11	V13
<b>ATENÇÃO RODOVIA!!!</b>			
<b>Deslocamento</b>			
3,04		1' 0.50.31 1' 0.50.18 1' 0.51.24	D
<b>CDD!!! AO ATRAVESSAR A RODOVIA</b>			
<b>Deslocamento</b>			
3,10		1' 0.51.31 1' 0.51.18 1' 0.52.24	D D15
0,00			
0,54		45 0.52.31 42 0.52.18 39 0.53.24	V
1,48		0.53.46 0.53.38 0.54.51	V16
2,18		15 0.54.42 12 0.54.38 12 0.55.56	V
<b>TRONCO</b>			

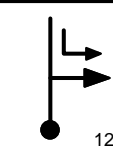
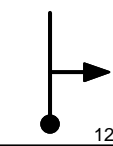
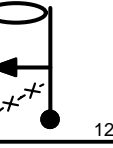
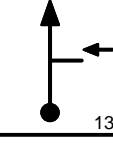
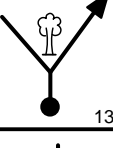
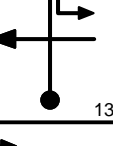
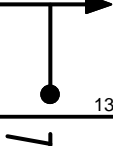
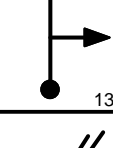
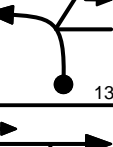
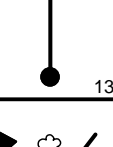
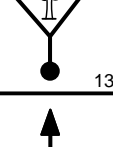
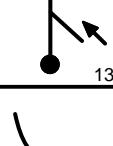



TRILHAS DO ALEMÃO		11/50	
2,38		0.55.30 0.55.38 0.56.56	V17
2,47		0.55.52 0.56.05 0.57.23	V17
2,53		0.56.06 0.56.23 0.57.41	V17
2,92		0.57.40 0.58.20 0.59.38	V17
3,25		0.58.59 0.59.59 1.01.17	V17
<b>CDD!!! CHIFRE</b>			
4,06		1.02.14 1.04.02 1.05.20	V17
4,24		1.02.57 1.04.56 1.06.14	V17
4,25		36 1.02.59 33 1.04.59 30 1.06.17	V
<b>AMEIXA</b>			
4,57		18 1.03.31 15 1.05.34 12 1.06.55	V
4,60		36 1.03.37 33 1.05.41 30 1.07.04	V
4,87		1.04.04 1.06.11 1.07.37	V20
4,99		45 1.04.16 42 1.06.24 39 1.07.51	V
5,58		45 1.05.03 42 1.07.14 39 1.08.45	V
0,00			V V22



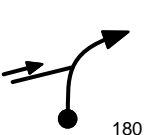
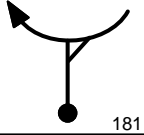
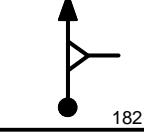
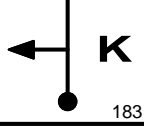
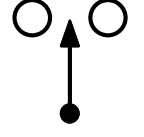
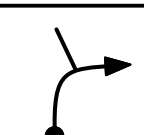
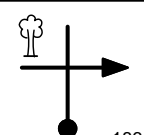

TRILHAS DO ALEMÃO		12/50	
0,52		1.05.45 1.07.59 1.09.33	V22
1,50		1.07.03 1.09.23 1.11.04	V22
1,78		15 1.07.26 12 1.09.47 12 1.11.30	V
1,80		1.07.31 1.09.53 1.11.36	V23
1,87		1.07.47 1.10.14 1.11.57	V23
1,95		1.08.07 1.10.38 1.12.21	V23
2,05		1.08.31 1.11.08 1.12.51	V23
2,09		1.08.40 1.11.20 1.13.03	V23
2,18		1.09.02 1.11.47 1.13.30	V23
2,29		1.09.28 1.12.20 1.14.03	V23
2,36		1.09.45 1.12.41 1.14.24	V23
2,72		1.11.11 1.14.29 1.16.12	V23
2,78		1.11.26 1.14.47 1.16.30	V23
<b>Neutralizado</b>			

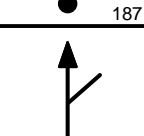
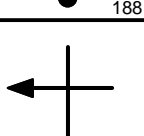
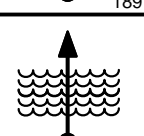
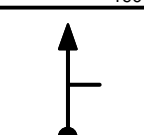
TRILHAS DO ALEMÃO		13/50	
2,84		2' 1.11.40 1' 1.15.05 1' 1.16.48	N
<b>0,00</b>	<b>N</b>	45 1.13.40 42 1.16.05 39 1.17.48	V
0,35		1.14.08 1.16.35 1.18.20	V25
0,84		1.14.47 1.17.17 1.19.05	V25
1,46		18 1.15.37 15 1.18.10 12 1.20.03	V
1,50		1.15.45 1.18.20 1.20.15	V26
1,53		1.15.51 1.18.27 1.20.24	V26
<b>ARVORE CAÍDA</b>			
1,54		1.15.53 1.18.29 1.20.27	V26
1,59		1.16.03 1.18.41 1.20.42	V26
1,94		1.17.13 1.20.05 1.22.27	V26
1,97		1.17.19 1.20.12 1.22.36	V26
<b>ÁRVORE CAÍDA</b>			
1,98		1.17.21 1.20.15 1.22.39	V26
2,04		1.17.33 1.20.29 1.22.57	V26

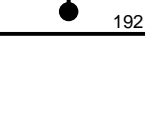
TRILHAS DO ALEMÃO		14/50	
2,18		1.18.01 1.21.03 1.23.39	V26
2,25		1.18.15 1.21.20 1.24.00	V26
2,71		1.19.47 1.23.10 1.26.18	V26
2,91		1.20.27 1.23.58 1.27.18	V26
3,08		1.21.01 1.24.39 1.28.09	V26
3,46		1.22.17 1.26.10 1.30.03	V26
4,13		45 1.24.31 42 1.28.51 39 1.33.24	V
4,52		1.25.02 1.29.24 1.34.00	V27
5,12		1.25.50 1.30.16 1.34.55	V27
<b>Neutralizado</b>			
5,65		3' 1.26.33 2' 1.31.01 1' 1.35.44	N
<b>0,00</b>	<b>N</b>	51 1.29.33 48 1.33.01 45 1.36.44	V
1,58		1.31.24 1.35.00 1.38.50	V29
2,43		1.32.24 1.36.03 1.39.58	V29

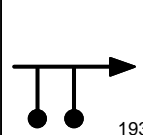
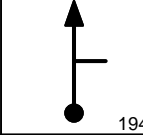
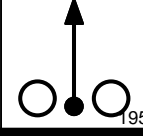
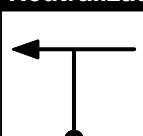
TRILHAS DO ALEMÃO		15/50	
4,58		1.34.56 1.38.45 1.42.50	V29
5,63		1.36.10 1.40.03 1.44.14	V29
5,87		1.36.27 1.40.21 1.44.33	V29
7,11		1.37.54 1.41.54 1.46.13	V29
8,01		1.38.58 1.43.02 1.47.25	V29
8,35		1.39.22 1.43.27 1.47.52	V29
8,73		1.39.49 1.43.56 1.48.22	V29
8,81		1.39.54 1.44.02 1.48.29	V29
9,00		1.40.08 1.44.16 1.48.44	V29
9,58		1.40.49 1.45.00 1.49.30	V29
10,51		1.41.54 1.46.09 1.50.45	V29
11,24		1.42.46 1.47.04 1.51.43	V29
12,22		1.43.55 1.48.18 1.53.01	V29
12,49		1.44.14 1.48.38 1.53.23	V29

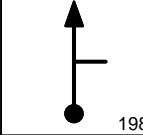
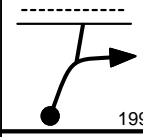
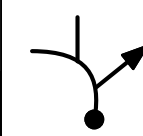
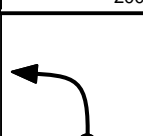
TRILHAS DO ALEMÃO		16/50
12,69		1.44.28 1.48.53 1.53.39 V29
13,04		1.44.53 1.49.19 1.54.07 V29
13,53		1.45.28 1.49.56 1.54.46 V29
13,87		1.45.52 1.50.21 1.55.13 V29
14,56		12 1.46.40 12 1.51.13 12 1.56.09 V V30
0,00		1.46.52 1.51.25 1.56.21 V30
0,04		1.47.22 1.51.55 1.56.51 V30
0,14		1.47.22 1.51.55 1.56.51 V30
<b>GÁZZZZZ</b>		
0,16		1.47.28 1.52.01 1.56.57 V30
0,20		1.47.40 1.52.13 1.57.09 V30
0,34		1.48.22 1.52.55 1.57.51 V30
0,55		1.49.25 1.53.58 1.58.54 V30
0,80		1.50.40 1.55.13 2.00.09 V30
<b>SUBA GÁZZZZZ</b>		
0,81		1.50.43 1.55.16 2.00.12 V30

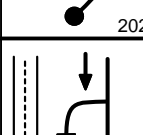
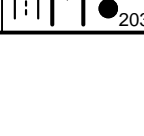

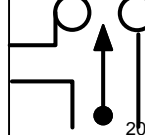
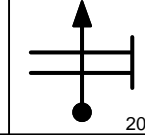
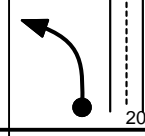
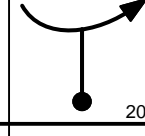
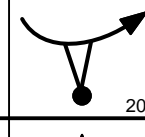
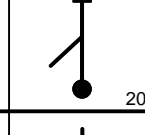
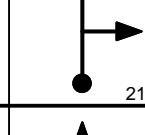
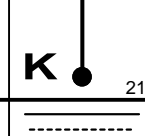
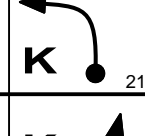
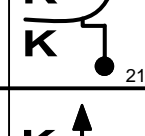
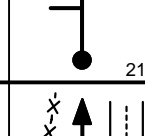
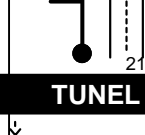
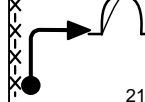



TRILHAS DO ALEMÃO		17/50
0,84		1.50.52 1.55.25 2.00.21 V30
0,85		1.50.55 1.55.28 2.00.24 V30
0,92		42 1.51.16 39 1.55.49 36 2.00.45 V
<b>Neutralizado</b>		
2,29		5' 1.53.14 3' 1.57.56 2' 2.03.02 N
		
0,00	<b>N</b>	39 1.58.14 36 2.00.56 33 2.05.02 V
0,10		1.58.23 2.01.06 2.05.13 V33
2,07		2.01.25 2.04.23 2.08.47 V33
2,16		24 2.01.33 21 2.04.32 18 2.08.57 V V34
0,00		2.01.45 2.04.45 2.09.13 V34
0,08		2.02.20 2.05.25 2.09.59 V34
<b>ÁRVORE CAÍDA</b>		
0,31		2.03.05 2.06.16 2.10.59 V34
0,61		2.03.05 2.06.16 2.10.59 V34



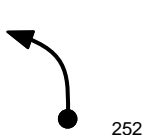
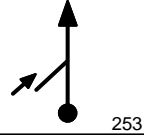
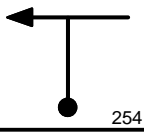
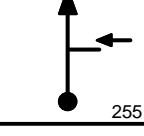
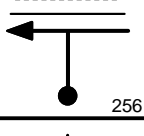

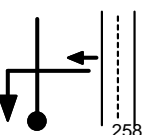

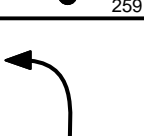
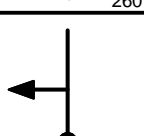
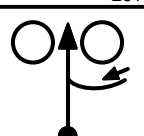
TRILHAS DO ALEMÃO		18/50
0,80		2.03.33 2.06.49 2.11.37 V34
0,90		2.03.48 2.07.06 2.11.57 V34
1,05		2.04.11 2.07.32 2.12.27 V34
1,10		33 2.04.18 30 2.07.40 27 2.12.37 V
1,14		2.04.23 2.07.45 2.12.43 V35
1,57		2.05.09 2.08.37 2.13.40 V35
1,63		2.05.16 2.08.44 2.13.48 V35
1,83		2.05.38 2.09.08 2.14.15 V35
1,92		2.05.48 2.09.19 2.14.27 V35
2,10		2.06.07 2.09.40 2.14.51 V35
2,19		2.06.17 2.09.51 2.15.03 V35
2,34		2.06.33 2.10.09 2.15.23 V35
<b>TUNEL</b>		
2,48		2.06.49 2.10.26 2.15.41 V35

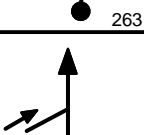

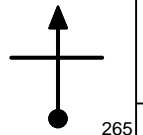
TRILHAS DO ALEMÃO		19/50
2,65		2.07.07 2.10.46 2.16.04 V35
2,86		2.07.30 2.11.11 2.16.32 V35
<b>MUITO CUIDADO</b>		
2,88		2.07.32 2.11.14 2.16.35 V35
3,04		24 2.07.50 21 2.11.33 18 2.16.56 V
3,22		2.08.17 2.12.04 2.17.32 V36
3,32		2.08.32 2.12.21 2.17.52 V36
3,48		2.08.56 2.12.48 2.18.24 V36
3,52		2.09.02 2.12.55 2.18.32 V36
3,57		2.09.09 2.13.04 2.18.42 V36
3,99		2.10.12 2.14.16 2.20.06 V36
4,05		2.10.21 2.14.26 2.20.18 V36
4,08		18 2.10.26 15 2.14.31 12 2.20.24 V
4,15		2.10.40 2.14.48 2.20.45 V37

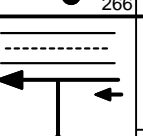
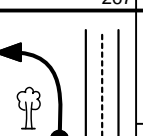
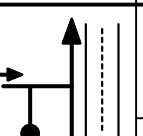
TRILHAS DO ALEMÃO		20/50
4,17		2.10.44 2.14.53 2.20.51 V37
4,28		39 2.11.06 36 2.15.19 33 2.21.24 V
4,91		2.12.04 2.16.22 2.22.33 V38
5,73		2.13.20 2.17.44 2.24.02 V38
<b>M.M.S.</b>		
6,13		21 2.13.57 18 2.18.24 15 2.24.46 V
6,22		2.14.12 2.18.42 2.25.07 V39
6,73		2.15.39 2.20.24 2.27.10 V39
6,74		2.15.41 2.20.26 2.27.12 V39
<b>CRUZE A RODOVIA E NEUTRALIZE DO OUTRO LADO</b>		
<b>Neutralizado</b>		
6,85		5' 2.16.00 3' 2.20.48 2' 2.27.39 N
<b>SUBA GÁZZZZ, BANDEIRAS!!!</b>		
0,00		15 2.21.00 12 2.23.48 12 2.29.39 V
0,01		2.21.02 2.23.51 2.29.42 V41

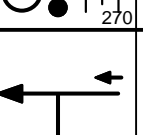
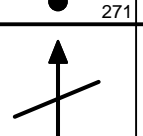

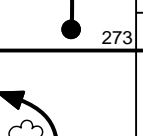
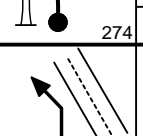
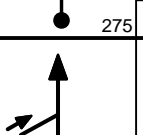
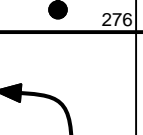

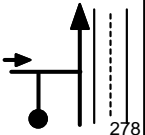
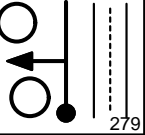
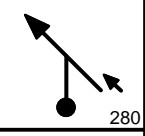
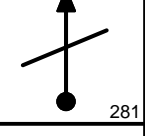
TRILHAS DO ALEMÃO		21/50
<b>TRONCO</b>		
0,07		2.21.17 2.24.09 2.30.00 V41
0,14		2.21.34 2.24.30 2.30.21 V41
<b>RUMO AS ÁRVORES E BANDEIRAS</b>		
0,15		2.21.36 2.24.33 2.30.24 V41
0,33		2.22.19 2.25.27 2.31.18 V41
<b>DESÇA</b>		
0,40		2.22.36 2.25.48 2.31.39 V41
<b>GDD!!! VALETA</b>		
0,48		2.22.55 2.26.12 2.32.03 V41
<b>CURVA DE NÍVEL</b>		
0,54		2.23.10 2.26.30 2.32.21 V41
0,63		2.23.31 2.26.57 2.32.48 V41
0,65		2.23.36 2.27.03 2.32.54 V41
0,70		2.23.48 2.27.18 2.33.09 V41
0,75		2.24.00 2.27.33 2.33.24 V41
<b>DESÇA</b>		

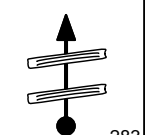
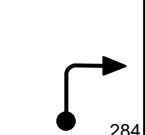
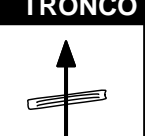
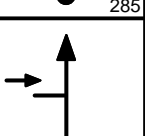
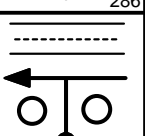
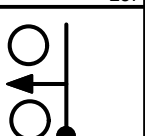
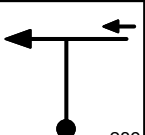

TRILHAS DO ALEMÃO		22/50
0,79		2.24.10 2.27.45 2.33.36 V 41
0,89		2.24.34 2.28.15 2.34.06 V 41
0,95		2.24.48 2.28.33 2.34.24 V 41
1,00		2.25.00 2.28.48 2.34.39 V 41
1,01		2.25.02 2.28.51 2.34.42 V 41
1,05		2.25.12 2.29.03 2.34.54 V 41
<b>SUBA GÁZZZZ</b>		
1,15		2.25.36 2.29.33 2.35.24 V 41
<b>TRONCO</b>		
1,23		2.25.55 2.29.57 2.35.48 V 41
1,31		2.26.14 2.30.21 2.36.12 V 41
1,32		2.26.17 2.30.24 2.36.15 V 41
1,35		2.26.24 2.30.33 2.36.24 V 41
<b>DESCA</b>		
1,40		2.26.36 2.30.48 2.36.39 V 41
1,50		2.27.00 2.31.18 2.37.09 V 41

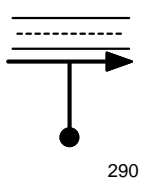

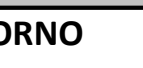
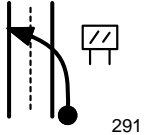
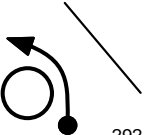
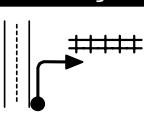
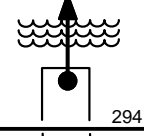
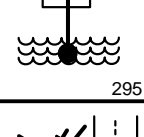
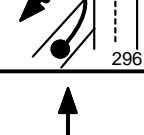
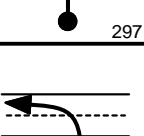
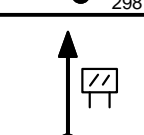
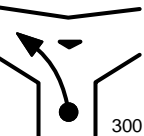

TRILHAS DO ALEMÃO		23/50
1,56		2.27.14 2.31.36 2.37.27 V 41
<b>SUBA GÁZZZZ</b>		
1,65		2.27.36 2.32.03 2.37.54 V 41
1,69		2.27.46 2.32.15 2.38.06 V 41
1,74		2.27.58 2.32.30 2.38.21 V 41
1,78		2.28.07 2.32.42 2.38.33 V 41
<b>SUBA GÁZZZZ</b>		
1,83		2.28.19 2.32.57 2.38.48 V 41
1,92		2.28.41 2.33.24 2.39.15 V 41
1,98		2.28.55 2.33.42 2.39.33 V 41
<b>SUBA GÁZZZZ</b>		
2,07		2.29.17 2.34.09 2.40.00 V 41
2,14		2.29.34 2.34.30 2.40.21 V 41
2,16		2.29.38 2.34.36 2.40.27 V 41
2,19		2.29.46 2.34.45 2.40.36 V 41
2,25		2.30.00 2.35.03 2.40.54 V 41

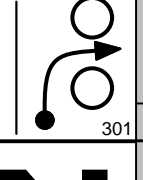
TRILHAS DO ALEMÃO		24/50
2,31		2.30.14 2.35.21 2.41.12 V 41
2,34		2.30.22 2.35.30 2.41.21 V 41
2,45		2.30.48 2.36.03 2.41.54 V 41
2,49		2.30.58 2.36.15 2.42.06 V 41
2,58		2.31.19 2.36.42 2.42.33 V 41
<b>CHIFRES</b>		
2,66		2.31.38 2.37.06 2.42.57 V 41
2,72		2.31.53 2.37.24 2.43.15 V 41
<b>TRONCO</b>		
2,77		2.32.05 2.37.39 2.43.30 V 41
2,82		2.32.17 2.37.54 2.43.45 V 41
2,90		2.32.36 2.38.18 2.44.09 V 41
2,97		2.32.53 2.38.39 2.44.30 V 41
3,00		2.33.00 2.38.48 2.44.39 V 41
<b>PELO ACOSTAMENTO!!!</b>		
<b>Deslocamento</b>		

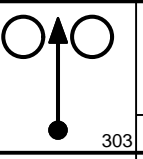
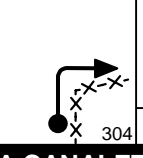
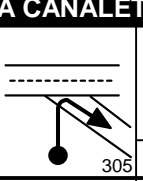
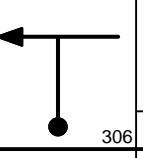
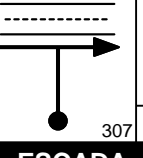
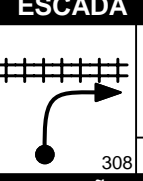
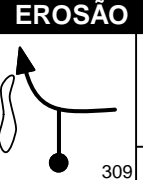
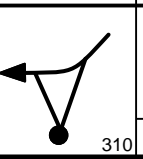
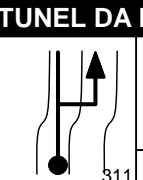
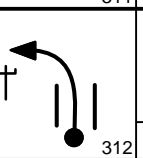
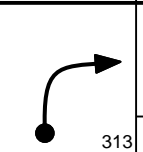

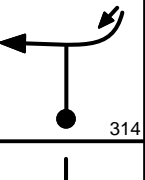
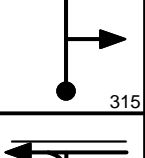
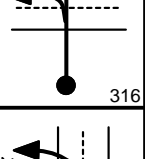
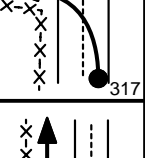
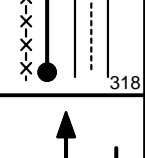
TRILHAS DO ALEMÃO		25/50	
3,08		3'	2.33.19
		3'	2.39.12
		3'	2.45.03
0,00		D	D42
			
<b>RUMO AO RETORNO</b>			
<b>PLACA ROLÂNDIA</b>			
0,16			
		D42	
<b>RETORNE</b>			
0,23			
		D42	
<b>DESÇA</b>			
0,25		12	2.36.19
		12	2.42.12
		12	2.48.03
		V	
0,27			2.36.25
			2.42.18
			2.48.09
		V43	
0,29			2.36.31
			2.42.24
			2.48.15
		V43	
0,40			2.37.04
			2.42.57
			2.48.48
		V43	
0,48			2.37.28
			2.43.21
			2.49.12
		V43	
0,55			2.37.49
			2.43.42
			2.49.33
		V43	
0,64			2.38.16
			2.44.09
			2.50.00
		V43	
0,94			2.39.46
			2.45.39
			2.51.30
		V43	
<b>Neutralizado</b>			

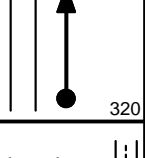
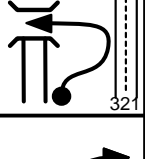
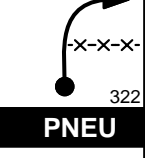
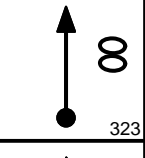
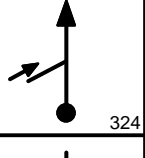
TRILHAS DO ALEMÃO		26/50	
0,99		2'	2.40.01
		1'	2.45.54
		1'	2.51.45
		N	
0,00		18	2.42.01
		15	2.46.54
		12	2.52.45
		V	
0,12			2.42.25
			2.47.23
			2.53.21
		V45	
0,19			2.42.39
			2.47.40
			2.53.42
		V45	
<b>NA CANALETA</b>			
0,26			2.42.53
			2.47.57
			2.54.03
		V45	
0,36			2.43.13
			2.48.21
			2.54.33
		V45	
0,37			2.43.15
			2.48.23
			2.54.36
		V45	
<b>ESCADA</b>			
0,40			2.43.21
			2.48.30
			2.54.45
		V45	
<b>EROSÃO</b>			
0,44			2.43.29
			2.48.40
			2.54.57
		V45	
0,46			2.43.33
			2.48.45
			2.55.03
		V45	
<b>ENTRE TUNEL DA DIREITA</b>			
0,49			2.43.39
			2.48.52
			2.55.12
		V45	
0,57			2.43.55
			2.49.11
			2.55.36
		V45	
0,61			2.44.03
			2.49.21
			2.55.48
		V45	

TRILHAS DO ALEMÃO		27/50	
0,67			2.44.15
			2.49.35
			2.56.06
		V45	
0,73			2.44.27
			2.49.49
			2.56.24
		V45	
0,95			2.45.11
			2.50.42
			2.57.30
		V45	
1,26			2.46.13
			2.51.57
			2.59.03
		V45	
1,41			2.46.43
			2.52.33
			2.59.48
		V45	
1,54			2.47.09
			2.53.04
			3.00.27
		V45	
<b>FORA DA CANALETA</b>			
1,64			2.47.29
			2.53.28
			3.00.57
		V45	
1,73			2.47.47
			2.53.49
			3.01.24
		V45	
1,89			2.48.19
			2.54.28
			3.02.12
		V45	
<b>PNEU</b>			
1,90			2.48.21
			2.54.30
			3.02.15
		V45	
2,02			2.48.45
			2.54.59
			3.02.51
		V45	
2,09			2.48.59
			2.55.16
			3.03.12
		V45	
<b>Deslocamento</b>			

TRILHAS DO ALEMÃO		28/50	
2,30		10'	2.49.41
0,00		10'	2.56.06
		10'	3.04.15
		D	D46
0,36			
			D46
1,73			
			D46
1,85			
			D46
2,11			
			D46
2,12		18	2.59.41
0,00		15	3.06.06
		12	3.14.15
		V	V47
0,04			2.59.49
			3.06.16
			3.14.27
			V47
0,39			3.00.59
			3.07.40
			3.16.12
			V47
0,41			3.01.03
			3.07.45
			3.16.18
			V47
0,54			3.01.29
			3.08.16
			3.16.57
			V47
0,56			3.01.33
			3.08.21
			3.17.03
			V47
0,62			3.01.45
			3.08.35
			3.17.21
			V47
<b>GÁZZZZZ</b>			
0,66			3.01.53
			3.08.45
			3.17.33
			V47





TRILHAS DO ALEMÃO		29/50	
0,87			3.02.35
			3.09.35
			3.18.36
			V47
1,10			3.03.21
			3.10.30
			3.19.45
			V47
1,11			3.03.23
			3.10.33
			3.19.48
			V47
1,13			3.03.27
			3.10.37
			3.19.54
			V47
1,16			3.03.33
			3.10.45
			3.20.03
			V47
1,23			3.03.47
			3.11.01
			3.20.24
			V47
1,28			3.03.57
			3.11.13
			3.20.39
			V47
1,33			3.04.07
			3.11.25
			3.20.54
			V47
1,37			3.04.15
			3.11.35
			3.21.06
			V47
1,38			3.04.17
			3.11.37
			3.21.09
			V47
1,46			3.04.33
			3.11.57
			3.21.33
			V47
1,48			3.04.37
			3.12.01
			3.21.39
			V47
1,54			3.04.49
			3.12.16
			3.21.57
			V47
<b>GÁZZZZZ</b>			



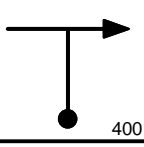
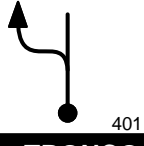
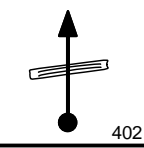
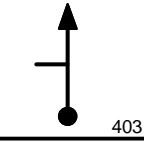
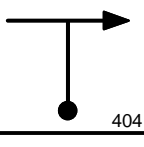
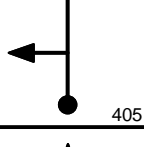
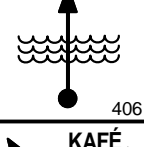
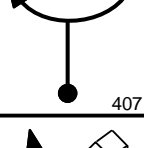
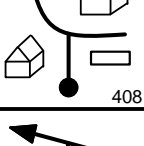

TRILHAS DO ALEMÃO		30/50	
1,57			3.04.55
			3.12.23
			3.22.06
			V47
1,79			3.05.39
			3.13.16
			3.23.12
			V47
2,02			3.06.25
			3.14.11
			3.24.21
			V47
2,03			3.06.27
			3.14.13
			3.24.24
			V47
2,05			3.06.31
			3.14.18
			3.24.30
			V47
2,08			3.06.37
			3.14.25
			3.24.39
			V47
2,15			3.06.51
			3.14.42
			3.25.00
			V47
2,18			3.06.57
			3.14.49
			3.25.09
			V47
2,24			3.07.09
			3.15.04
			3.25.27
			V47
2,25			3.07.11
			3.15.06
			3.25.30
			V47
2,27			3.07.15
			3.15.11
			3.25.36
			V47
2,52			3.08.05
			3.16.11
			3.26.51
			V47
2,57			3.08.15
			3.16.23
			3.27.06
			V47
2,63			3.08.27
			3.16.37
			3.27.24
			V47

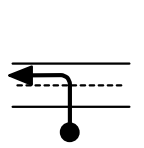
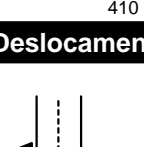
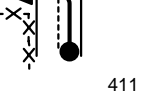

TRILHAS DO ALEMÃO		31/50	
<b>Deslocamento</b>			
2,76		2'	3.08.53
		2'	3.17.09
		2'	3.28.03
0,00		D	D48
0,03			
			D48
0,15		21	3.10.53
		18	3.19.09
		15	3.30.03
		V	
0,22			3.11.05
			3.19.23
			3.30.19
		V49	
0,25			3.11.10
			3.19.29
			3.30.27
		V49	
0,27			3.11.14
			3.19.33
			3.30.31
		V49	
0,30			3.11.19
			3.19.39
			3.30.39
		V49	
<b>CAPIM</b>			
0,37			3.11.31
			3.19.53
			3.30.55
		V49	
<b>Deslocamento</b>			
0,58		5'	3.12.07
		5'	3.20.35
		5'	3.31.46
0,00		D	D50
0,33			
			D50
0,78			
			D50
1,06			
			D50

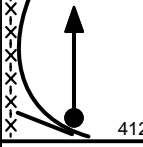
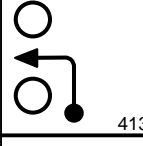
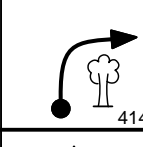
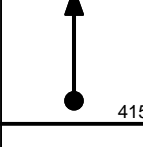
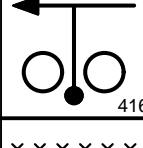
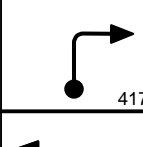

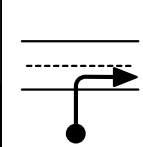
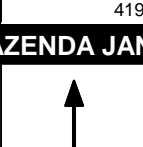
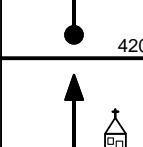
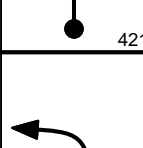
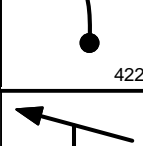

TRILHAS DO ALEMÃO		32/50	
1,28			
		378	D50
<b>PREFERENCIAL</b>			
1,46			
		379	D50
<b>PREFERENCIAL</b>			
1,90			
		380	D50
<b>COLEGIO KENEDY</b>			
2,08			
		381	D50
2,26			
		382	D50
<b>Neutralizado</b>			
2,67		35'	3.17.07
		30'	3.25.35
		25'	3.36.46
		N	
<b>PIZZARIA BLACK BURGER</b>			
<b>Deslocamento</b>			
0,00		10'	3.52.07
		10'	3.55.35
		10'	4.01.46
		D	
0,05			
		385	D52
0,38			
		386	D52
<b>COLEGIO KENEDY</b>			
0,55			
		387	D52

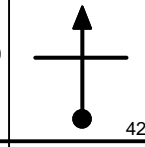
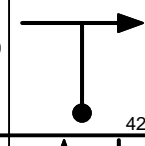
TRILHAS DO ALEMÃO		33/50	
<b>PREFERENCIAL</b>			
0,74			
		388	D52
1,35			
		389	D52
1,58			
		390	D52
<b>APAE</b>			
1,66			
		391	D52
2,17			
		392	D52
2,76			
		393	D52
<b>LINHA DO TREM</b>			
2,91			
		394	D52
3,45			
		395	D52
<b>MANGA</b>			
3,49		18	4.02.07
		15	4.05.35
		12	4.11.46
		V	V53
0,00			
		396	
0,01			4.02.09
			4.05.37
			4.11.49
		V53	
0,19			4.02.45
			4.06.20
			4.12.43
		V53	
<b>TRONCO</b>			
0,32			4.03.11
			4.06.51
			4.13.22
		V53	

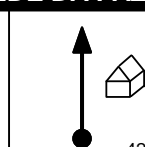
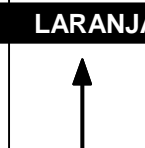
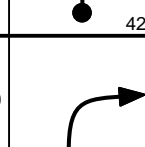
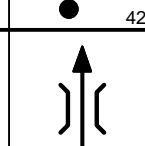
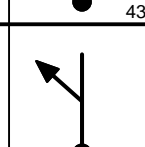
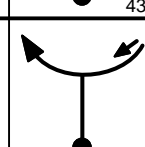
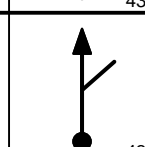
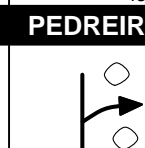
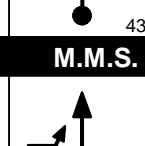
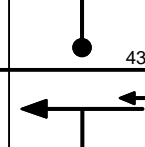

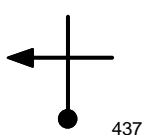
TRILHAS DO ALEMÃO		34/50	
0,49		4.03.45 4.07.32 4.14.13	V53
0,68		4.04.23 4.08.18 4.15.10	V53
<b>TRONCO</b>			
0,89		4.05.05 4.09.08 4.16.13	V53
0,91		4.05.09 4.09.13 4.16.19	V53
0,93		4.05.13 4.09.18 4.16.25	V53
0,94		4.05.15 4.09.20 4.16.28	V53
1,12		4.05.51 4.10.03 4.17.22	V53
1,21		4.06.09 4.10.25 4.17.49	V53
1,59		4.07.25 4.11.56 4.19.43	V53
1,69		4.07.45 4.12.20 4.20.13	V53
<b>Deslocamento</b>			
1,81		3' 4.08.09 3' 4.12.49 3' 4.20.49	D D54
0,00			
<b>Deslocamento</b>			
1,24		1' 4.11.09 1' 4.15.49 1' 4.23.49	D D55
0,00			

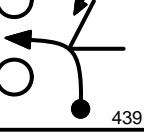
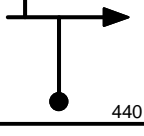
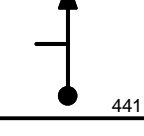
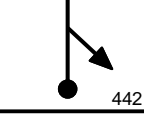
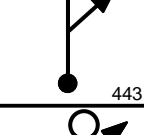
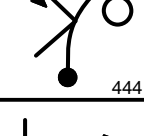
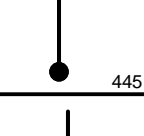
TRILHAS DO ALEMÃO		35/50	
0,11			D55
0,39		12 4.12.09 12 4.16.49 12 4.24.49	V
0,40		4.12.12 4.16.52 4.24.52	V56
0,60		4.13.12 4.17.52 4.25.52	V56
0,78		36 4.14.06 33 4.18.46 30 4.26.46	V
1,20		4.14.48 4.19.32 4.27.36	V57
1,30		4.14.58 4.19.43 4.27.48	V57
<b>Deslocamento</b>			
1,37		5' 4.15.05 5' 4.19.50 5' 4.27.57	D D58
0,00			
<b>FAZENDA JANETA</b>			
0,87			D58
2,99			D58
3,13		36 4.20.05 33 4.24.50 30 4.32.57	V V59
0,00			
0,33		4.20.38 4.25.26 4.33.36	V59

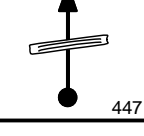
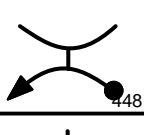
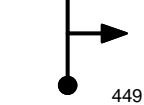
TRILHAS DO ALEMÃO		36/50	
0,56		4.21.01 4.25.51 4.34.04	V59
0,86		4.21.31 4.26.24 4.34.40	V59
0,94		4.21.39 4.26.33 4.34.49	V59
<b>SEDE DA FAZENDA</b>			
1,09		4.21.54 4.26.49 4.35.07	V59
<b>LARANJA</b>			
1,12		4.21.57 4.26.53 4.35.11	V59
1,56		4.22.41 4.27.41 4.36.04	V59
1,60		4.22.45 4.27.45 4.36.09	V59
1,68		4.22.53 4.27.54 4.36.18	V59
1,71		4.22.56 4.27.57 4.36.22	V59
1,77		4.23.02 4.28.03 4.36.29	V59
<b>PEDREIRA</b>			
2,39		4.24.04 4.29.11 4.37.43	V59
<b>M.M.S.</b>			
2,43		4.24.08 4.29.15 4.37.48	V59
2,68		4.24.33 4.29.43 4.38.18	V59

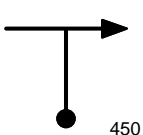
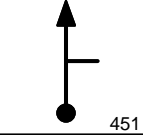
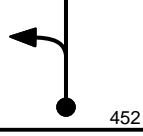
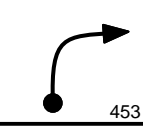
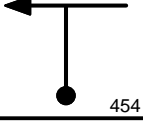
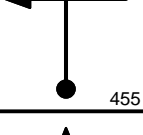
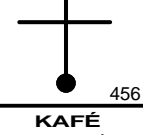
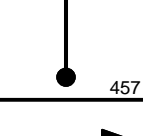
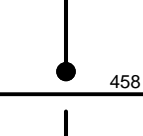
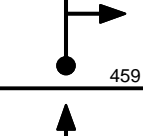
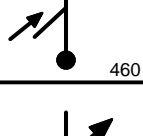
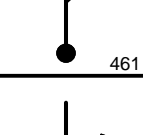
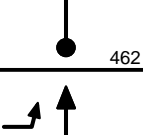
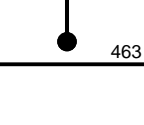
TRILHAS DO ALEMÃO		37/50
3,09		4.25.14 4.30.27 4.39.07 V59
3,25		4.25.30 4.30.45 4.39.27 V59
3,40		4.25.45 4.31.01 4.39.45 V59
3,50		4.25.55 4.31.12 4.39.57 V59
3,52		4.25.57 4.31.14 4.39.59 V59
3,73		4.26.18 4.31.37 4.40.24 V59
3,76		4.26.21 4.31.41 4.40.28 V59
3,83		4.26.28 4.31.48 4.40.36 V59
3,93		4.26.38 4.31.59 4.40.48 V59
3,95		4.26.40 4.32.01 4.40.51 V59
<b>CHIFRES</b>		
4,03		4.26.48 4.32.10 4.41.00 V59
4,34		4.27.19 4.32.44 4.41.37 V59
4,54		4.27.39 4.33.06 4.42.01 V59

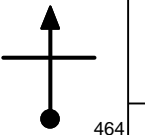
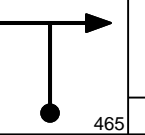
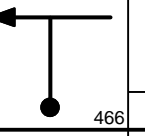
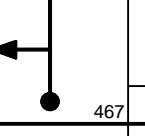
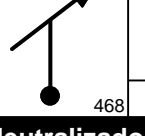
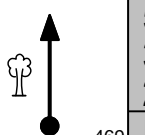
TRILHAS DO ALEMÃO		38/50
4,64		4.27.49 4.33.17 4.42.13 V59
4,75		4.28.00 4.33.29 4.42.27 V59
5,09		4.28.34 4.34.06 4.43.07 V59
5,15		4.28.40 4.34.12 4.43.15 V59
5,17		4.28.42 4.34.14 4.43.17 V59
5,41		4.29.06 4.34.41 4.43.46 V59
5,63		4.29.28 4.35.05 4.44.12 V59
6,03		4.30.08 4.35.48 4.45.00 V59
6,14		4.30.19 4.36.00 4.45.13 V59
7,00		4.31.45 4.37.34 4.46.57 V59
7,01		4.31.46 4.37.35 4.46.58 V59
7,07		4.31.52 4.37.42 4.47.05 V59
7,29		4.32.14 4.38.06 4.47.31 V59
7,40		4.32.25 4.38.18 4.47.45 V59

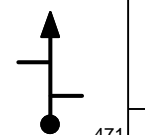
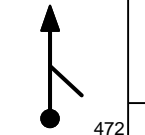
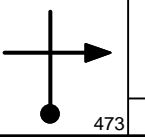
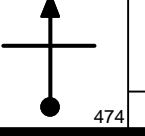
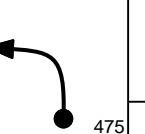
TRILHAS DO ALEMÃO		39/50
7,81		4.33.06 4.39.02 4.48.34 V59
8,01		4.33.26 4.39.24 4.48.58 V59
8,12		4.33.37 4.39.36 4.49.11 V59
8,19		4.33.44 4.39.44 4.49.19 V59
8,32		4.33.57 4.39.58 4.49.35 V59
<b>Neutralizado</b>		
8,35		5' 4.34.00 3' 4.40.01 2' 4.49.39 N
		
0,00	<b>N</b>	45 4.39.00 42 4.43.01 39 4.51.39 V
0,08		4.39.06 4.43.08 4.51.46 V61
0,25		4.39.20 4.43.23 4.52.02 V61
1,25		4.40.40 4.44.48 4.53.34 V61
2,19		4.41.55 4.46.09 4.55.01 V61
<b>CURVA PERIGOSA</b>		
3,22		4.43.17 4.47.37 4.56.36 V61

TRILHAS DO ALEMÃO		40/50	
3,65			4.43.52 4.48.14 4.57.15 V61
4,27			4.44.41 4.49.07 4.58.13 V61
4,42			4.44.53 4.49.20 4.58.27 V61
5,09			4.45.47 4.50.18 4.59.28 V61
5,35		21 18 15 V	4.46.08 4.50.40 4.59.52
5,50			4.46.34 4.51.10 5.00.28 V62
5,53			4.46.39 4.51.16 5.00.36 V62
5,73			4.47.13 4.51.56 5.01.24 V62
<b>Neutralizado</b>			
5,77		3' 2' 1' N	4.47.20 4.52.04 5.01.33
5,77		21 18 15 V	4.50.20 4.54.04 5.02.33
5,82			4.50.28 4.54.14 5.02.45 V64
5,83			4.50.30 4.54.16 5.02.48 V64
5,87		36 33 30 V	4.50.37 4.54.24 5.02.57

TRILHAS DO ALEMÃO		41/50	
5,93			4.50.43 4.54.30 5.03.04 V65
6,01			4.50.51 4.54.39 5.03.14 V65
6,43		18 15 12 V	4.51.33 4.55.25 5.04.04
6,49			4.51.45 4.55.39 5.04.22 V66
6,68			4.52.23 4.56.25 5.05.19 V66
<b>PARA O LAGO</b>			
6,94			4.53.15 4.57.27 5.06.37 V66
6,95			4.53.17 4.57.30 5.06.40 V66
6,99			4.53.25 4.57.39 5.06.52 V66
7,48			4.55.03 4.59.37 5.09.19 V66
7,87			4.56.21 5.01.11 5.11.16 V66
8,01			4.56.49 5.01.44 5.11.58 V66
<b>GÁZZZZZ</b>			
8,06			4.56.59 5.01.56 5.12.13 V66
<b>PEDRAS</b>			
8,11			4.57.09 5.02.08 5.12.28 V66

TRILHAS DO ALEMÃO		42/50	
<b>TANQUE DE COMBUSTÍVEL</b>			
<b>Neutralizado</b>			
8,15		3' 2' 1' N	4.57.17 5.02.18 5.12.40
0,00		9 9 9 V	5.00.17 5.04.18 5.13.40
0,02			5.00.25 5.04.26 5.13.48 V68
<b>NA VALA</b>			
0,04			5.00.33 5.04.34 5.13.56 V68
0,08		15 12 12 V	5.00.49 5.04.50 5.14.12
0,12			5.00.59 5.05.02 5.14.24 V69
<b>GÁZZZZZ</b>			
0,31			5.01.44 5.05.59 5.15.21 V69
<b>CURVA DE NIVEL</b>			
0,38			5.02.01 5.06.20 5.15.42 V69
0,48			5.02.25 5.06.50 5.16.12 V69
0,68			5.03.13 5.07.50 5.17.12 V69
0,71			5.03.20 5.07.59 5.17.21 V69

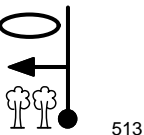
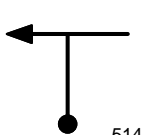
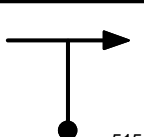
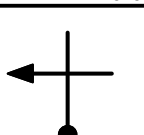
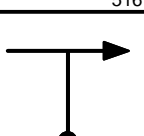
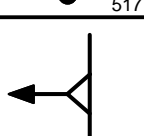
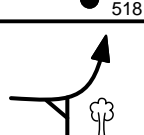
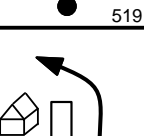
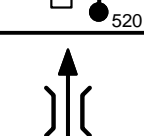
TRILHAS DO ALEMÃO		43/50	
0,77		5.03.35 5.08.17 5.17.39	V69
1,12		36 5.04.59 33 5.10.02 30 5.19.24	V
1,22		5.05.09 5.10.13 5.19.36	V70
1,44		5.05.31 5.10.37 5.20.03	V70
1,76		45 5.06.03 42 5.11.12 39 5.20.41	V
1,78		5.06.04 5.11.13 5.20.43	V71
2,76		18 5.07.23 15 5.12.37 12 5.22.13	V
2,85		5.07.41 5.12.59 5.22.40	V72
2,98		45 5.08.07 42 5.13.30 39 5.23.19	V

### PARALELEPIPEDO

#### Deslocamento

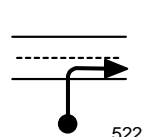

3,68		2' 5.09.03 2' 5.14.30 2' 5.24.24	D
------	---	--	---

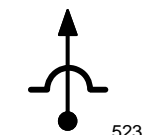
#### QUEBRA MOLA

4,60			D74
------	---	--	-----

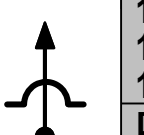
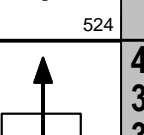
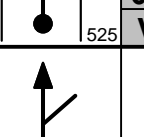
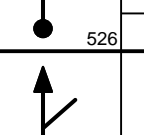
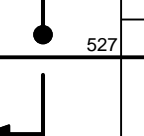
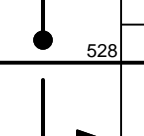
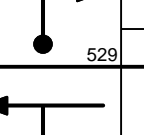
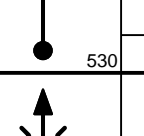
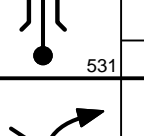
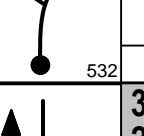
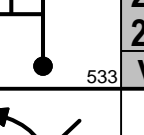
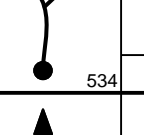
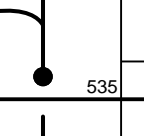
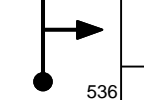
#### Deslocamento

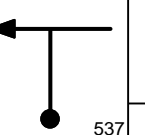
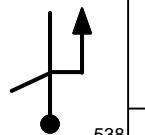
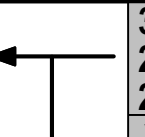
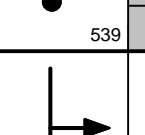
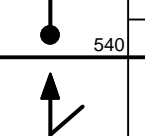
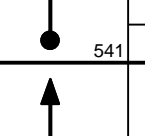
TRILHAS DO ALEMÃO		44/50	
4,81		1' 5.11.03 1' 5.16.30 1' 5.26.24	D D75
0,00			
0,33		42 5.12.03 39 5.17.30 36 5.27.24	V
0,47		5.12.15 5.17.43 5.27.38	V76
0,77		5.12.40 5.18.11 5.28.08	V76
3,20		5.16.09 5.21.55 5.32.11	V76
3,90		5.17.09 5.23.00 5.33.21	V76
4,07		5.17.23 5.23.15 5.33.38	V76
5,06		5.18.48 5.24.47 5.35.17	V76
5,10		5.18.51 5.24.50 5.35.21	V76
5,17		30 5.18.57 27 5.24.57 24 5.35.28	V
5,50		5.19.37 5.25.41 5.36.18	V77
5,78		5.20.11 5.26.18 5.37.00	V77
5,90		5.20.25 5.26.34 5.37.18	V77

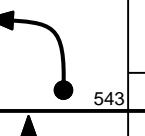
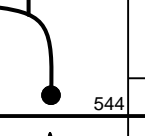
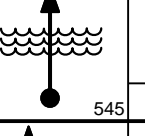
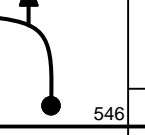
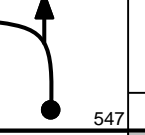
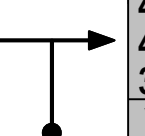
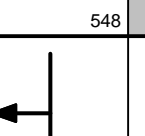
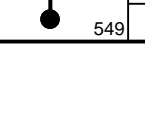
TRILHAS DO ALEMÃO		45/50	
6,04		5.20.42 5.26.53 5.37.39	V77
6,14		5.20.54 5.27.06 5.37.54	V77
7,11		30 5.22.50 27 5.29.15 24 5.40.19	V V78
0,00			
0,28		5.23.24 5.29.53 5.41.01	V78
0,75		5.24.20 5.30.55 5.42.12	V78
1,22		5.25.17 5.31.58 5.43.22	V78
<b>BEIRA A MATA</b>			
1,67		5.26.11 5.32.58 5.44.30	V78
2,13		5.27.06 5.33.59 5.45.39	V78
2,25		5.27.20 5.34.15 5.45.57	V78
2,45		5.27.44 5.34.42 5.46.27	V78
2,61		5.28.03 5.35.03 5.46.51	V78
4,27		45 5.31.23 42 5.38.45 39 5.51.00	V V79
0,00			
2,23		5.34.21 5.41.56 5.54.25	V79

TRILHAS DO ALEMÃO		46/50	
3,16		550	5.35.35 5.43.16 5.55.51 V79
3,21		551	5.35.39 5.43.20 5.55.56 V79
3,27		552	5.35.44 5.43.25 5.56.01 V79
3,75		39 36 33 V	5.36.23 5.44.06 5.56.46 V
3,77		554	5.36.25 5.44.08 5.56.48 V80
3,91		555	5.36.37 5.44.22 5.57.03 V80
4,66		556	5.37.47 5.45.37 5.58.25 V80
4,68		557	5.37.49 5.45.39 5.58.27 V80
4,76		558	5.37.56 5.45.47 5.58.36 V80
5,30		559	5.38.46 5.46.41 5.59.35 V80
5,66		560	5.39.19 5.47.17 6.00.14 V80
<b>RODOVIA, PELO ACOSTAMENTO</b>			
6,40		51 48 45 V	5.40.27 5.48.31 6.01.35 V81
0,00		561	

TRILHAS DO ALEMÃO		47/50	
0,30		562	5.40.48 5.48.54 6.01.59 V81
1,02		563	5.41.39 5.49.48 6.02.56 V81
2,62		564	5.43.32 5.51.48 6.05.04 V81
2,69		565	5.43.37 5.51.53 6.05.10 V81
3,26		566	5.44.17 5.52.36 6.05.56 V81
3,56		33 30 27 V	5.44.39 5.52.58 6.06.20 V
3,79		568	5.45.04 5.53.26 6.06.50 V82
3,95		569	5.45.21 5.53.45 6.07.12 V82
4,43		570	5.46.13 5.54.43 6.08.16 V82
4,52		571	5.46.23 5.54.53 6.08.28 V82
5,01		572	5.47.17 5.55.52 6.09.33 V82
5,08		27 24 21 V	5.47.24 5.56.01 6.09.42 V
5,17		574	5.47.36 5.56.14 6.09.58 V83
5,38		575	5.48.04 5.56.46 6.10.34 V83

TRILHAS DO ALEMÃO		48/50	
5,50		576	5.48.20 5.57.04 6.10.54 V83
5,54		577	5.48.26 5.57.10 6.11.01 V83
5,57		578	5.48.30 5.57.14 6.11.06 V83
5,72		579	5.48.50 5.57.37 6.11.32 V83
5,74		580	5.48.52 5.57.40 6.11.35 V83
5,76		45 42 39 V	5.48.55 5.57.43 6.11.39 V
6,48		582	5.49.53 5.58.44 6.12.45 V84
7,09		583	5.50.41 5.59.37 6.13.42 V84
7,26		51 48 45 V	5.50.55 5.59.51 6.13.57 V
8,37		585	5.52.13 6.01.14 6.15.26 V85
10,27		586	5.54.28 6.03.37 6.17.58 V85
<b>Deslocamento</b>			
10,65		20' 20' 20'	5.54.54 6.04.05 6.18.28
0,00		D D	D86 D86
<b>POSTO ESSO</b>			
1,54		588	D86

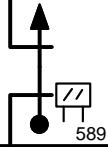
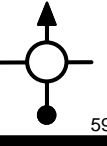
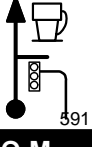
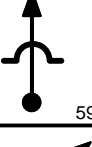
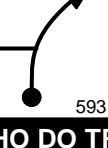
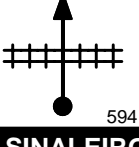
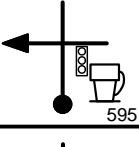
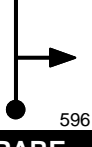
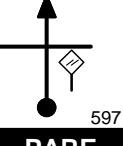
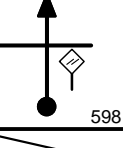
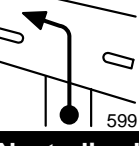
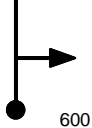

TRILHAS DO ALEMÃO		49/50	
5,96			D86
<b>TREVO</b>			
6,47			D86
<b>SINALEIRO RESPEITE</b>			
6,75			D86
<b>Q.M.</b>			
7,51			D86
8,04			D86
<b>TRILHO DO TREM</b>			
8,12			D86
<b>SINALEIRO</b>			
8,16			D86
8,31			D86
<b>PARE</b>			
8,42			D86
<b>PARE</b>			
8,55			D86
8,62			D86
<b>Neutralizado</b>			
8,79		0'	6.14.54
		0'	6.24.05
		0'	6.38.28
		N	

TRILHAS DO ALEMÃO		50/50	
<b>FIM DA PROVA !!</b>			
			
<p>Planilha gerada pelo programa TotemPlanilha que foi criado pela Totem.</p>			
<p>ESTA É UMA DAS FORMAS QUE A TOTEM PARTICIPA DA EVOLUÇÃO DO OFF ROAD.</p>			
<p><a href="http://WWW.TOTEMONLINE.COM.BR">WWW.TOTEMONLINE.COM.BR</a></p>			
<p>ROLANDIA_R02.pla</p>			
ADCB5245B905		v5.39	