

	<b>ATENÇÃO</b>
	<b>CUIDADO</b>
	<b>PERIGO</b>

**Tempo de Prova**

Master Senior	04:45:25
Over Junior	05:02:34
Novatos Turismc	05:22:53



**Início de Prova**

**AFERIÇÃO E DESLOCAMENTO**

0,00		5'	0.00.00
		5'	0.00.00
		5'	0.00.00
		D	

**Q.M.**

0,28			
------	--	--	--

**NA PRAÇA**

0,33			
------	--	--	--

**ATT. AFER POSTE**

0,45			
------	--	--	--

0,58			
------	--	--	--

**AFER POSTE**

0,87			
------	--	--	--

**AFER/ FIM DESLOC**

1,46		51	0.05.00
		48	0.05.00
		45	0.05.00
0,00		V	V2

0,46		0.05.32	0.05.35	0.05.37
------	--	---------	---------	---------

1,60		0.06.53	0.07.00	0.07.08
------	--	---------	---------	---------

2,34		0.07.45
		0.07.56
		0.08.07

3,00		0.08.32
		0.08.45
		0.09.00

4,41		0.10.11
		0.10.31
		0.10.53

5,14		0.11.03
		0.11.26
		0.11.51

**ATT NO TRIGO**

6,37		36	0.12.30
		33	0.12.58
		30	0.13.30
		V	V3

0,00			
------	--	--	--

**B.MATO**

0,04		0.12.34
		0.13.02
		0.13.34

0,55		0.13.25
		0.13.58
		0.14.36

**ATT**

1,98		0.15.48
		0.16.34
		0.17.27

**ESTRADÃO**

1,99		51	0.15.49
		48	0.16.35
		45	0.17.28
		V	

**NO MATO**

2,14		27	0.15.59
		24	0.16.46
		21	0.17.40
		V	

**TRILHA DO POMBO**

2,23		0.16.11
		0.17.00
		0.17.56

2,52		0.16.50
		0.17.43
		0.18.46

**BREJO**

2,60		0.17.01
		0.17.55
		0.18.59

2,70		0.17.14
		0.18.10
		0.19.16

**PINGUELA I**

2,72		0.17.17
		0.18.13
		0.19.20

2,78		0.17.25
		0.18.22
		0.19.30

**EROS**

2,86		0.17.35
		0.18.34
		0.19.44

2,89		0.17.39
		0.18.39
		0.19.49

3,23		0.18.25
		0.19.30
		0.20.47

3,25		0.18.27
		0.19.33
		0.20.51

3,60		0.19.14
		0.20.25
		0.21.51











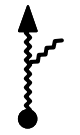

**PINGUELA II**





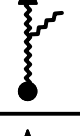





3,62		0.19.17
		0.20.28
		0.21.54

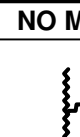





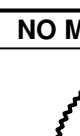

3,68		0.19.25
		0.20.37
		0.22.04

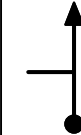
**EROS**

3,75		0.19.34
		0.20.48
		0.22.16

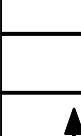
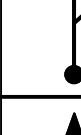
II Tamarana		pag 4 de 34	
3,78		0.19.38 0.20.52 0.22.22	34
4,12		0.20.23 0.21.43 0.23.20	35
4,32		0.20.50 0.22.13 0.23.54	36
4,38		0.20.58 0.22.22 0.24.04	37
4,55		0.21.21 0.22.48 0.24.34	38
<b>PINGUELA III</b>			
4,56		0.21.22 0.22.49 0.24.35	39
4,61		0.21.29 0.22.57 0.24.44	40
<b>EROS</b>			
4,69		0.21.39 0.23.09 0.24.58	41
4,71		0.21.42 0.23.12 0.25.01	42
5,08		0.22.31 0.24.07 0.26.04	43
5,09		0.22.33 0.24.09 0.26.06	44
<b>SUBIDÃO</b>			
5,21		0.22.49 0.24.27 0.26.27	45
<b>B.CERCA</b>			
5,38		0.23.11 0.24.52 0.26.56	46

II Tamarana		pag 5 de 34	
5,76		0.24.02 0.25.49 0.28.01	47
5,81		0.24.09 0.25.57 0.28.10	48
<b>NO MATO</b>			
5,87		0.24.17 0.26.06 0.28.20	49
<b>PINHEIRO</b>			
5,93		0.24.25 0.26.15 0.28.30	50
<b>POR DENTRO ESCOLA</b>			
5,95		36 0.24.27 33 0.26.18 30 0.28.34 V	51
5,97		0.24.29 0.26.20 0.28.36	52
6,00		0.24.32 0.26.23 0.28.40	53
6,02		0.24.34 0.26.25 0.28.42	54
6,09		0.24.41 0.26.33 0.28.50	55
6,21		30 0.24.53 27 0.26.46 24 0.29.05 V	56
<b>NO MATO</b>			
6,27		0.25.00 0.26.54 0.29.14	57
6,54		0.25.33 0.27.30 0.29.54	58
<b>LIMÃO</b>			

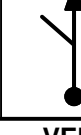
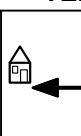
II Tamarana		pag 6 de 34	
6,62		0.25.42 0.27.41 0.30.06	59
6,71		0.25.53 0.27.53 0.30.20	60
<b>ESTRADÃO</b>			
6,76		3' 0.25.59 3' 0.27.59 3' 0.30.27 N	61
0,00		51 0.28.59 48 0.30.59 45 0.33.27 V	62
<b>PASA</b>			
0,15		0.29.10 0.31.11 0.33.39	63
0,64		0.29.44 0.31.47 0.34.18	64
0,70		0.29.49 0.31.52 0.34.23	65
2,48		0.31.54 0.34.05 0.36.46	66
3,96		0.33.39 0.35.56 0.38.44	67
6,10		0.36.10 0.38.37 0.41.35	68
<b>VENDA</b>			
6,15		10' 0.36.13 10' 0.38.41 10' 0.41.39 N	69
<b>TOTEM</b>			
0,00		51 0.46.13 48 0.48.41 45 0.51.39 V	70

II Tamarana		pag 7 de 34	
0,03			0.46.15 0.48.43 0.51.42
0,37			0.46.39 0.49.08 0.52.09
1,40			0.47.52 0.50.26 0.53.31
2,40			0.49.03 0.51.41 0.54.51
2,60			0.49.17 0.51.56 0.55.07
3,09			0.49.51 0.52.32 0.55.46
3,82			0.50.43 0.53.27 0.56.45
4,07		42 0.51.01 39 0.53.46 36 0.57.05 V	
4,11			0.51.04 0.53.49 0.57.09
4,31			0.51.21 0.54.08 0.57.29
4,61			0.51.47 0.54.36 0.57.59
4,81		33 0.52.04 30 0.54.54 27 0.58.19 V	
NO MATO			
4,89			0.52.13 0.55.04 0.58.30

II Tamarana		pag 8 de 34	
4,98			0.52.23 0.55.14 0.58.42
5,02		42 0.52.27 39 0.55.19 36 0.58.47 V	
5,06			0.52.30 0.55.23 0.58.51
5,13		30 0.52.36 27 0.55.29 24 0.58.58 V	
NO MATO			
5,23			0.52.48 0.55.43 0.59.13
PERIGO			
5,32			0.52.59 0.55.55 0.59.26
5,37			0.53.05 0.56.01 0.59.34
5,47			0.53.17 0.56.15 0.59.49
5,59		42 0.53.32 39 0.56.31 36 1.00.07 V	
5,75			0.53.45 0.56.46 1.00.23
5,79		30 0.53.49 27 0.56.49 24 1.00.27 V	
ATT NA GRAMA			
5,88			0.54.00 0.57.01 1.00.40
5,97			0.54.10 0.57.13 1.00.54

II Tamarana		pag 9 de 34	
6,03			0.54.18 0.57.21 1.01.03
6,15			0.54.32 0.57.37 1.01.21
ESTRADINHA			
6,19			0.54.37 0.57.43 1.01.27
6,34		48 0.54.55 45 0.58.03 42 1.01.49 V	
LAGOA			
6,69		48 0.55.21 45 0.58.31 42 1.02.19 V	V19
0,00			
1,19			0.56.50 1.00.06 1.04.01
1,25			0.56.55 1.00.11 1.04.06
1,43			0.57.08 1.00.25 1.04.22
1,48			0.57.12 1.00.29 1.04.26
1,74		51 0.57.31 58 1.00.50 48 1.04.48 V	
2,08			0.57.55 1.01.11 1.05.14
2,24			0.58.07 1.01.21 1.05.26
2,70			0.58.39 1.01.49 1.06.00

B.CERCA

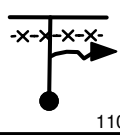
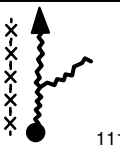
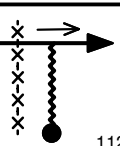
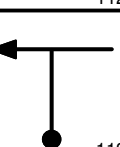
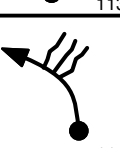
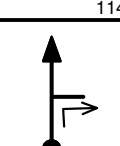
2,81		36	0.58.47
		33	1.01.56
		30	1.06.09
		V	
3,13			0.59.19
			1.02.31
			1.06.47
3,41		48	0.59.47
		45	1.03.02
		42	1.07.21
		V	
3,63			1.00.03
			1.03.19
			1.07.40
3,67			1.00.06
			1.03.22
			1.07.43
3,93			1.00.26
			1.03.43
			1.08.05

ALDEIA/ INDIOS

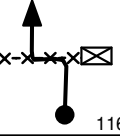
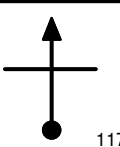
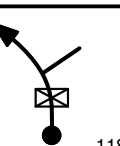
4,32		36	1.00.55
		33	1.04.14
		30	1.08.39
		V	
4,35			1.00.58
			1.04.18
			1.08.42
4,43			1.01.06
			1.04.26
			1.08.52

EROS

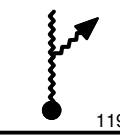
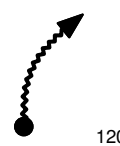
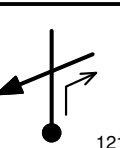
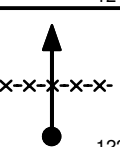
4,51		27	1.01.14
		24	1.04.35
		21	1.09.02
		V	
4,67			1.01.36
			1.04.59
			1.09.29
4,91		36	1.02.08
		33	1.05.35
		30	1.10.10
		V	
5,52			1.03.09
			1.06.42
			1.11.23

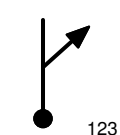
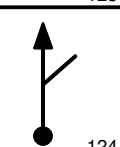
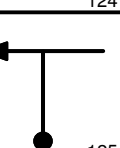
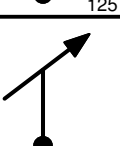
5,57			1.03.14
			1.06.47
			1.11.29
5,59			1.03.16
			1.06.49
			1.11.32
5,69			1.03.26
			1.07.00
			1.11.44
5,77			1.03.34
			1.07.09
			1.11.53

ESTRADÃO

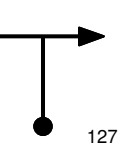
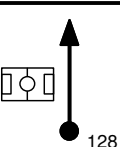
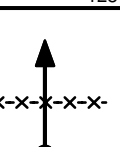
5,86		45	1.03.43
		42	1.07.19
		39	1.12.04
		V	
5,94			1.03.49
			1.07.26
			1.12.11
6,17		33	1.04.07
		30	1.07.45
		27	1.12.33
		V	V27

POSTE

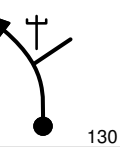
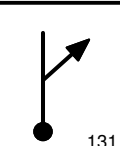
0,20			1.04.29
			1.08.09
			1.12.59
0,48			1.05.00
			1.08.43
			1.13.37

PERIGO

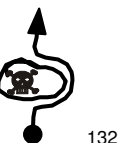
1,42			1.06.42
			1.10.36
			1.15.42



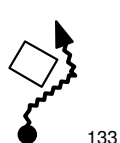



CONTORNE



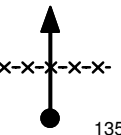

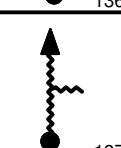
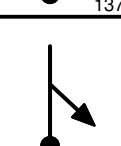
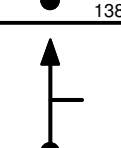
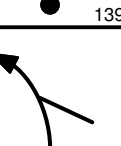
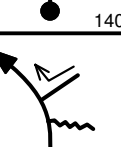
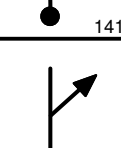

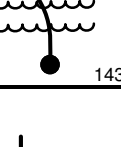
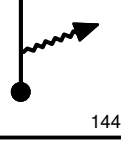

1,45		9	1.06.46
		9	1.10.39
		9	1.15.46
		V	

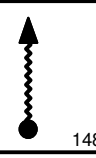

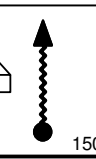

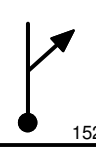
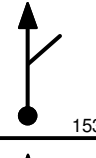
RIACHO

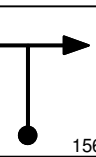

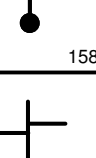

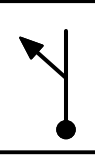
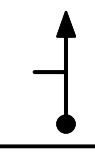
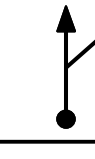
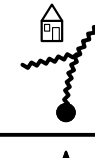
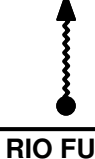

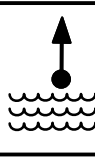
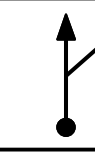
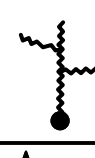
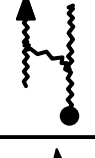

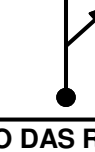
1,51			1.07.10
			1.11.03
			1.16.10

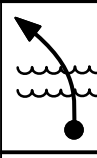
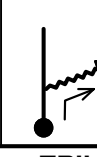
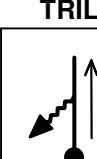
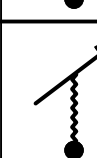
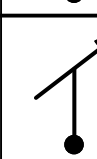
TRILHA DO GPS

1,53		24	1.07.18
		21	1.11.11
		18	1.16.18
		V	
1,89			1.08.12
			1.12.13
			1.17.30
2,59			1.09.57
			1.14.13
			1.19.50
2,91		36	1.10.45
		33	1.15.08
		30	1.20.54
		V	
3,08			1.11.02
			1.15.26
			1.21.14
4,78			1.13.52
			1.18.32
			1.24.38
5,08		42	1.14.22
		36	1.19.05
		33	1.25.14
		V	
5,92		33	1.15.34
		30	1.20.29
		27	1.26.46
		V	
RIO DAS ROUPAS			
5,94			1.15.36
			1.20.31
			1.26.49
5,98		33	1.15.40
		30	1.20.36
		27	1.26.54
		V	V33
0,05			1.15.46
			1.20.42
			1.27.01
0,23			1.16.05
			1.21.03
			1.27.25
0,29		24	1.16.12
		21	1.21.11
		18	1.27.33
		V	

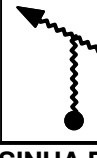

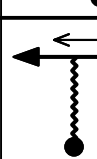

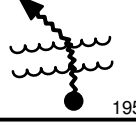

II Tamaranapag 13 de 34			
0,96		33 1.17.52 30 1.23.05 27 1.29.47	148 V
1,07		1.18.04 1.23.19 1.30.01	149
<b>INDIOS</b>			
1,32		1.18.31 1.23.49 1.30.35	150
1,41		36 1.18.41 33 1.23.59 30 1.30.47	151 V
1,73		1.19.13 1.24.34 1.31.25	152
1,77		1.19.17 1.24.39 1.31.30	153
2,25		1.20.05 1.25.31 1.32.28	154
2,81		42 1.21.01 39 1.26.32 36 1.33.35	155 V
<b>ESTRADÃO</b>			
3,22		45 1.21.36 42 1.27.10 39 1.34.16	156 V
<b>ALDEIA</b>			
6,38		36 1.25.49 33 1.31.41 30 1.39.07	157 V
7,04		36 1.26.55 33 1.32.53 30 1.40.27	158 V
<b>0,00</b>		<b>V40</b>	
0,35		1.27.30 1.33.31 1.41.09	159

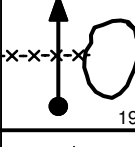
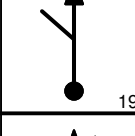
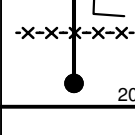
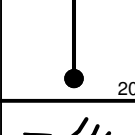
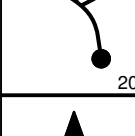
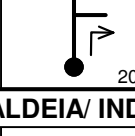
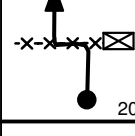
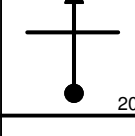
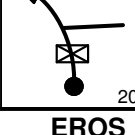
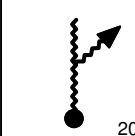
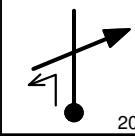
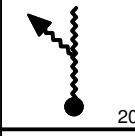
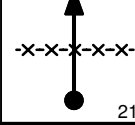
II Tamaranapag 14 de 34			
0,86		1.28.21 1.34.27 1.42.10	160
1,60		1.29.35 1.35.47 1.43.39	161
2,20		30 1.30.35 27 1.36.53 24 1.44.51	162 V
2,80		1.31.47 1.38.13 1.46.21	163
3,40		27 1.32.59 24 1.39.33 21 1.47.51	164 V
<b>RIO FUNDO</b>			
3,57		1.33.22 1.39.58 1.48.20	165
3,60		33 1.33.26 30 1.40.03 27 1.48.25	166 V
3,92		1.34.01 1.40.41 1.49.08	167
3,95		1.34.04 1.40.45 1.49.12	168
4,02		42 1.34.12 39 1.40.53 36 1.49.21	169 V
4,61		1.35.02 1.41.48 1.50.20	170
5,52		45 1.36.20 42 1.43.12 39 1.51.51	171 V
6,35		33 1.37.27 30 1.44.23 27 1.53.08	172 V
<b>RIO DAS ROUPAS</b>			

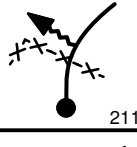
II Tamaranapag 15 de 34			
6,38		1.37.30 1.44.26 1.53.12	173
6,41		1.37.33 1.44.30 1.53.16	174
<b>TRILHA</b>			
6,47		24 1.37.40 21 1.44.37 18 1.53.24	175 V
6,61		42 1.38.01 39 1.45.01 36 1.53.52	176 V
6,65		1.38.04 1.45.05 1.53.56	177
6,84		33 1.38.20 30 1.45.23 27 1.54.15	178 V
7,44		1.39.26 1.46.35 1.55.35	179
7,65		1.39.49 1.47.00 1.56.03	180
7,66		1.39.50 1.47.01 1.56.04	181
<b>CASINHA DO HUGO</b>			
7,85		1.40.11 1.47.24 1.56.29	182
8,03		42 1.40.30 39 1.47.45 36 1.56.53	183 V
8,63		1.41.22 1.48.41 1.57.53	184
8,77		30 1.41.34 27 1.48.54 24 1.58.07	185 V

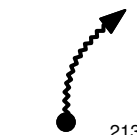
9,18		39	1.42.23
		36	1.49.48
		33	1.59.09
<b>0,00</b>		V	<b>V52</b>
186			
0,10			1.42.32
			1.49.58
			1.59.20
0,15		42	1.42.37
		39	1.50.03
		36	1.59.25
		V	
188			
0,55			1.43.11
			1.50.40
			2.00.05
189			
1,50		39	1.44.32
		36	1.52.08
		33	2.01.40
		V	
190			
<b>ATT. BEIRA CERCA</b>			
1,56		30	1.44.38
		27	1.52.14
		24	2.01.47
		V	
191			
<b>NO MATO</b>			
1,90		12	1.45.19
		12	1.52.59
		12	2.02.38
		V	
192			
<b>TRILHA DO VEINHO</b>			
1,98			1.45.43
			1.53.23
			2.03.02
193			
<b>CASA/ RUINAS</b>			
2,28			1.47.13
			1.54.53
			2.04.32
194			
<b>RIO</b>			
2,42		9	1.47.55
		9	1.55.35
		9	2.05.14
		V	
195			
2,50		5'	1.48.27
		5'	1.56.07
		5'	2.05.46
		N	
196			
2,50		45	1.53.27
		42	2.01.07
		39	2.10.46
		V	
197			
<b>LAGOA</b>			

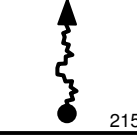
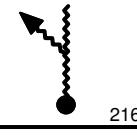
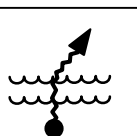
2,57			1.53.32
			2.01.13
			2.10.52
		198	
2,63			1.53.37
			2.01.18
			2.10.58
199			
3,76			1.55.08
			2.02.55
			2.12.42
200			
4,00			1.55.27
			2.03.16
			2.13.04
201			
4,05			1.55.31
			2.03.20
			2.13.09
202			
4,30			1.55.51
			2.03.41
			2.13.32
203			
<b>ALDEIA/ INDIOS</b>			
4,68		36	1.56.21
		33	2.04.14
		30	2.14.07
		V	
204			
4,71			1.56.24
			2.04.17
			2.14.10
205			
4,79			1.56.32
			2.04.26
			2.14.20
206			
<b>EROS</b>			
4,87		27	1.56.40
		24	2.04.35
		21	2.14.30
		V	
207			
5,28		39	1.57.35
		36	2.05.36
		33	2.15.40
		V	
208			
5,33			1.57.39
			2.05.41
			2.15.45
209			
5,68			1.58.12
			2.06.16
			2.16.24
210			

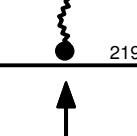
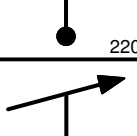
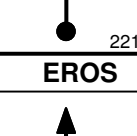
5,71			1.58.15
			2.06.19
			2.16.27
		211	
5,80		21	1.58.23
		18	2.06.28
		15	2.16.37
		V	
212			
<b>TRILHA DO LIMOEIRO</b>			
6,02			1.59.01
			2.07.12
			2.17.29
213			
6,12		15	1.59.18
		12	2.07.32
		9	2.17.53
		V	
214			
6,35		12	2.00.13
		9	2.08.41
		9	2.19.25
		V	
215			
6,72			2.02.04
			2.11.09
			2.21.53
216			
<b>RIO DO SENADOR</b>			
6,74		9	2.02.10
		9	2.11.17
		9	2.22.01
		V	
217			
<b>RUMO A ARVORE</b>			
6,77		24	2.02.22
		21	2.11.29
		18	2.22.13
		V	
218			
<b>TRILHO DE GADO</b>			
6,81		30	2.02.28
		27	2.11.36
		24	2.22.21
		V	
219			
7,60		36	2.04.03
		33	2.13.21
		30	2.24.20
		V	
220			
7,84		45	2.04.27
		42	2.13.48
		39	2.24.49
		V	
221			
<b>EROS</b>			
7,90			2.04.31
			2.13.53
			2.24.54
222			

8,10		2.04.47
		2.14.10
		2.25.13

8,51		2.05.20
		2.14.45
		2.25.51

8,97		2.05.57
		2.15.24
		2.26.33

9,40		2.06.31
		2.16.01
		2.27.13

**ESTRADAO**

9,45		51 2.06.35
		48 2.16.06
		45 2.27.17
		V <b>V71</b>

1,63		2.08.31
		2.18.08
		2.29.28

**M.S.C.**

3,55		2.10.46
		2.20.32
		2.32.01

**M.S.C.**

5,93		2.13.34
		2.23.30
		2.35.12

**VENDA**

6,62		30' 2.14.23
		30' 2.24.22
		30' 2.36.07
		N



**M.S.C**

0,00		51 2.44.23
		48 2.54.22
		45 3.06.07
		V

**M.S.C.**

0,00		2.44.44
		2.54.45
		3.06.31

0,30		2.44.44
		2.54.45
		3.06.31

**M.S.C.**

0,68		2.45.11
		2.55.13
		3.07.01

**ATT. M.S.C.**

1,94		2.46.40
		2.56.48
		3.08.42

3,07		2.47.59
		2.58.12
		3.10.13

3,45		2.48.26
		2.58.41
		3.10.43

4,02		2.49.07
		2.59.24
		3.11.29

4,75		45 2.49.58
		42 3.00.18
		39 3.12.27
		V

**SUBA NA TRILHA**

5,00		27 2.50.18
		24 3.00.40
		21 3.12.50
		V <b>V75</b>

**COQUEIRO**

0,11		2.50.33
		3.00.56
		3.13.09

0,17		2.50.41
		3.01.05
		3.13.19

**NO MATO**

0,22		18 2.50.47
		15 3.01.13
		12 3.13.28
		V

0,49		12 2.51.41
		12 3.02.18
		12 3.14.49
		V

**EROS RIO**

0,63		2.52.23
		3.03.00
		3.15.31

0,65		2.52.29
		3.03.06
		3.15.37

**LIMAO**

0,74		15 2.52.56
		15 3.03.33
		15 3.16.04
		V

**EROS**

0,87		18 2.53.28
		15 3.04.04
		12 3.16.35
		V

**CAVA**

0,92		2.53.38
		3.04.16
		3.16.50

0,98		2.53.50
		3.04.30
		3.17.08

1,04		3' 2.54.02
		3' 3.04.45
		3' 3.17.26
		N

**ESTRADAO**

0,00		51 2.57.02
		48 3.07.45
		45 3.20.26
		V

0,19		42 2.57.15
		39 3.07.59
		36 3.20.41
		V



0,26		2.57.21
		3.08.05
		3.20.48

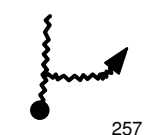
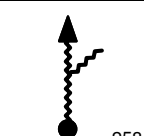
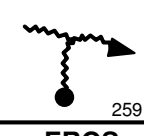
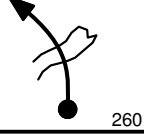
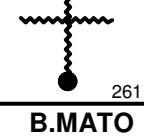
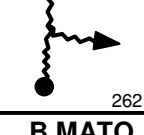
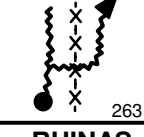
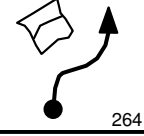
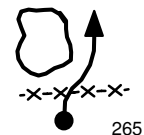
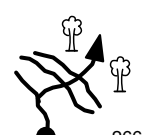
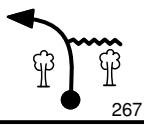
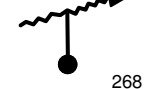

0,59		39 2.57.49
		36 3.08.36
		33 3.21.21
		V

1,20		2.58.46
		3.09.37
		3.22.28

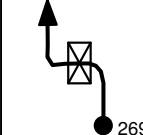
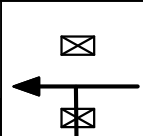
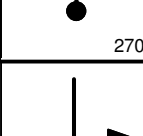
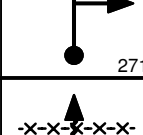
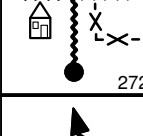

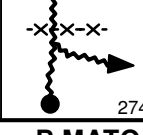
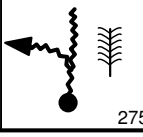
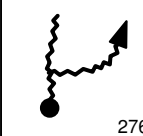
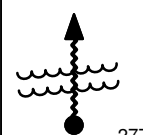
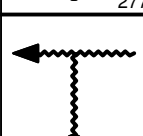
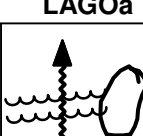
**B.MATO**

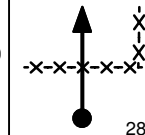
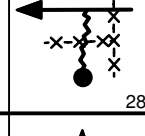
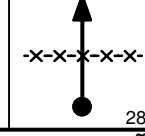
II Tamaranapag 22 de 34			
1,55		36 2.59.18 33 3.10.12 30 3.23.06	V
B.MATO			
1,67		2.59.30 3.10.25 3.23.20	
1,80		2.59.43 3.10.39 3.23.36	
EROS			
1,85		2.59.48 3.10.45 3.23.42	
1,90		2.59.53 3.10.50 3.23.48	
B.MATO			
2,12		3.00.15 3.11.14 3.24.14	
B.MATO			
2,33		39 3.00.36 36 3.11.37 33 3.24.39	V
RUINAS			
2,76		3.01.16 3.12.20 3.25.26	
LAGOA			
2,82		33 3.01.21 30 3.12.26 27 3.25.33	V
BREJO			
2,94		3.01.34 3.12.40 3.25.49	
3,00		3.01.41 3.12.47 3.25.57	
3,05		3.01.46 3.12.53 3.26.04	

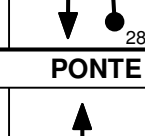
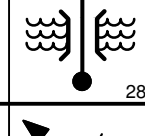
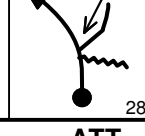
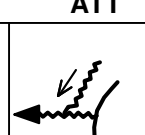
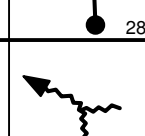
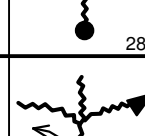
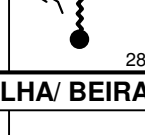
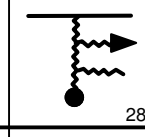
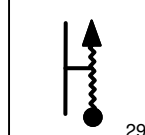

II Tamaranapag 23 de 34			
3,14		3.01.56 3.13.04 3.26.16	
ESTRADAO			
3,20		48 3.02.03 45 3.13.11 42 3.26.24	V V87
0,00			
1,05		30 3.03.21 27 3.14.35 24 3.27.54	V
1,33		3.03.55 3.15.13 3.28.36	
1,40		3.04.03 3.15.22 3.28.46	
NO PASTO			
1,60		21 3.04.27 18 3.15.49 15 3.29.16	V
B.MATO			
1,72		3.04.48 3.16.13 3.29.45	
B.MATO			
1,76		15 3.04.55 12 3.16.21 12 3.29.54	V
RIACHO			
1,78		3.05.00 3.16.27 3.30.00	
1,85		30 3.05.16 27 3.16.48 24 3.30.21	V
LAGOa			
1,98		3.05.32 3.17.05 3.30.41	
BODE			

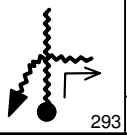
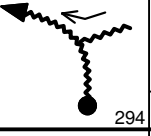
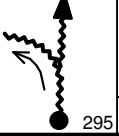
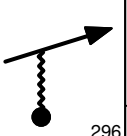
II Tamaranapag 24 de 34			
2,06		3.05.42 3.17.16 3.30.53	
2,17		36 3.05.55 33 3.17.30 30 3.31.09	V
2,27		3.06.05 3.17.41 3.31.21	
ESTRADÃO			
2,46		51 3.06.24 48 3.18.02 45 3.31.44	V
PONTE			
2,84		3.06.51 3.18.31 3.32.15	
2,89		45 3.06.54 42 3.18.34 39 3.32.19	V
ATT			
2,99		42 3.07.02 39 3.18.43 36 3.32.28	V
3,99		3.08.28 3.20.15 3.34.08	
4,17		3.08.43 3.20.32 3.34.26	
TRILHA/ BEIRA ESTR.			
4,40		3.09.03 3.20.53 3.34.49	
4,63		3.09.23 3.21.14 3.35.12	
4,81		3.09.38 3.21.31 3.35.30	
5,78		3.11.01 3.23.00 3.37.07	

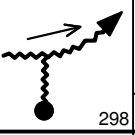
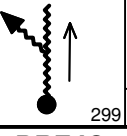
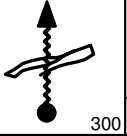
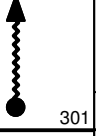
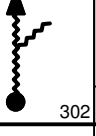
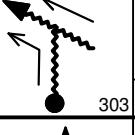
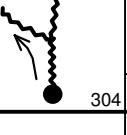
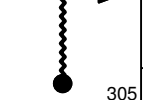

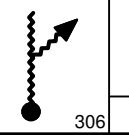
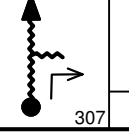
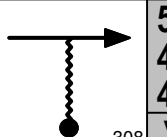
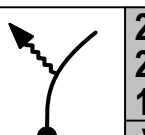
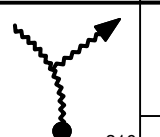
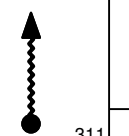
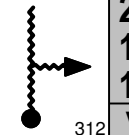
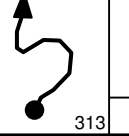
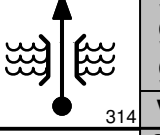
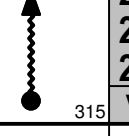
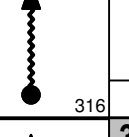
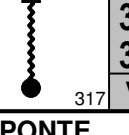
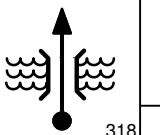
II Tamaranapag 25 de 34			
5,97			3.11.18 3.23.18 3.37.26
6,88			3.12.36 3.24.42 3.38.57
6,93			3.12.40 3.24.47 3.39.02
ESTRADAO			
7,81		51 48 45 V	3.13.55 3.26.08 3.40.30
7,92		42 39 36 V	3.14.03 3.26.16 3.40.39
<b>0,00</b>		V	<b>V97</b>
0,44			3.14.41 3.26.57 3.41.23
0,48			3.14.44 3.27.00 3.41.27
BREJO			
0,74		21 18 15 V	3.15.06 3.27.24 3.41.53
0,77		42 39 36 V	3.15.12 3.27.30 3.42.00
0,95		39 36 33 V	3.15.27 3.27.47 3.42.18
1,06			3.15.37 3.27.58 3.42.30
1,09			3.15.40 3.28.01 3.42.33
1,92			3.16.57 3.29.24 3.44.04

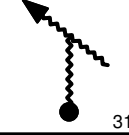
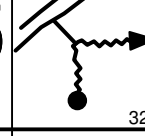
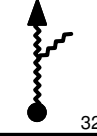
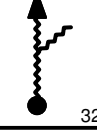
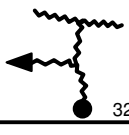
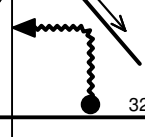
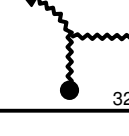
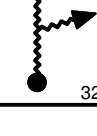
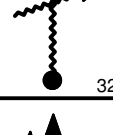
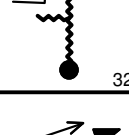
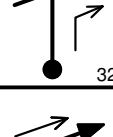
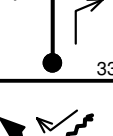
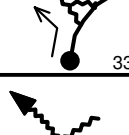
II Tamaranapag 26 de 34			
1,96			3.17.00 3.29.28 3.44.08
2,26			3.17.28 3.29.58 3.44.41
ESTRADAO			
2,64		51 48 45 V	3.18.03 3.30.36 3.45.22
CUIDADO			
2,97		24 21 18 V	3.18.26 3.31.01 3.45.49
3,53			3.19.50 3.32.37 3.47.41
3,58			3.19.58 3.32.45 3.47.51
3,77		21 18 15 V	3.20.26 3.33.18 3.48.29
3,92			3.20.52 3.33.48 3.49.05
4,40		9 9 9 V	3.22.14 3.35.24 3.51.00
4,48		27 24 21 V	3.22.46 3.35.56 3.51.32
4,58			3.23.00 3.36.11 3.51.49
4,90		36 33 30 V	3.23.42 3.36.59 3.52.44
PONTE			
5,39			3.24.31 3.37.52 3.53.43

II Tamaranapag 27 de 34			
5,44			3.24.36 3.37.58 3.53.49
5,75		39 36 33 V	3.25.07 3.38.32 3.54.26
5,94			3.25.25 3.38.51 3.54.47
6,04			3.25.34 3.39.01 3.54.57
7,62			3.28.00 3.41.39 3.57.50
7,67		27 24 21 V	3.28.05 3.41.44 3.57.55
7,74		36 33 30 V	3.28.14 3.41.54 3.58.07
8,19			3.28.59 3.42.43 3.59.01
8,40			3.29.20 3.43.06 3.59.26
8,64			3.29.44 3.43.32 3.59.55
8,99		5' 5' 5' N	3.30.19 3.44.10 4.00.37
<b>0,00</b>		51 48 45 V	3.35.19 3.49.10 4.05.37
0,08		42 39 36 V	3.35.24 3.49.16 4.05.44
1,09			3.36.51 3.50.50 4.07.25

1,27		333	3.37.06 3.51.06 4.07.43
2,18		334	3.38.24 3.52.30 4.09.14
2,23		335	3.38.29 3.52.35 4.09.19
<b>BREJO</b>			
2,48		27	3.38.50
		24	3.52.58
		21	4.09.44
		V	
2,52		36	3.38.56
		33	3.53.04
		30	4.09.51
		V	
2,71		338	3.39.15 3.53.25 4.10.13
2,81		339	3.39.25 3.53.36 4.10.25
2,83		340	3.39.27 3.53.38 4.10.28
3,67		341	3.40.51 3.55.09 4.12.09
3,71		42	3.40.55
		39	3.55.14
		36	4.12.13
		V	
4,00		343	3.41.19 3.55.41 4.12.42
4,93		344	3.42.39 3.57.06 4.14.15
5,03		345	3.42.48 3.57.16 4.14.25

5,05		346	3.42.49 3.57.17 4.14.27
<b>ATT. PONTE</b>			
5,14		27	3.42.57
		24	3.57.26
		21	4.14.36
		V	
<b>BREJO E PONTE</b>			
5,38		348	3.43.29 3.58.02 4.15.17
<b>PONTE</b>			
5,53		349	3.43.49 3.58.24 4.15.43
<b>PONTE</b>			
5,92		350	3.44.41 3.59.23 4.16.50
5,95		351	3.44.45 3.59.27 4.16.55
<b>RIO</b>			
5,97		12	3.44.48
		12	3.59.30
		12	4.16.59
		V	
6,04		36	3.45.09
		33	3.59.51
		30	4.17.20
		V	
6,20		354	3.45.25 4.00.09 4.17.39
<b>RIO</b>			
6,89		3'	3.46.34
		3'	4.01.24
		3'	4.19.02
		N	
6,89		42	3.49.34
		39	4.04.24
		36	4.22.02
		V	
7,01		45	3.49.44
		42	4.04.35
		39	4.22.14
		V	V121
0,00		357	

0,02		358	3.49.46 4.04.37 4.22.15
<b>ESTRADA O</b>			
0,94		51	3.50.59
		48	4.05.56
		45	4.23.40
		V	
2,27		360	3.52.33 4.07.35 4.25.27
4,80		361	3.55.32 4.10.45 4.28.49
4,86		362	3.55.36 4.10.50 4.28.54
5,70		45	3.56.35
		42	4.11.53
		39	4.30.01
		V	
<b>RIACHO</b>			
5,97		364	3.56.57 4.12.16 4.30.26
5,98		39	3.56.58
		36	4.12.17
		33	4.30.27
		V	
6,57		366	3.57.52 4.13.16 4.31.31
<b>B.MATO</b>			
6,92		367	3.58.24 4.13.51 4.32.10
7,21		368	3.58.51 4.14.20 4.32.41
<b>B,MATO</b>			
7,29		369	3.58.59 4.14.28 4.32.50
7,73		370	3.59.39 4.15.12 4.33.38

II Tamaranapag 31 de 34			
7,90			3.59.55 4.15.29 4.33.56
NO MATO			
8,12			4.00.15 4.15.51 4.34.20
RUINAS			
8,52			4.00.52 4.16.31 4.35.04
LAGOA			
8,58		36	4.00.58
		33	4.16.37
		30	4.35.11
<b>0,00</b>		V	<b>V125</b>
BREJO			
0,12			4.01.10 4.16.50 4.35.25
EST. ABANDONADA			
0,17			4.01.15 4.16.55 4.35.31
0,56		33	4.01.54
		30	4.17.38
		27	4.36.18
		V	
EROS			
0,60		30	4.01.58
		27	4.17.43
		24	4.36.23
		V	
GOIABINHA			
0,86		15	4.02.29
		15	4.18.17
		15	4.37.02
		V	
BREJO			
1,34			4.04.24 4.20.12 4.38.57
POÇO			
1,38			4.04.34 4.20.22 4.39.07
LAGE			

II Tamaranapag 32 de 34			
1,54		12	4.05.12
		12	4.21.00
		12	4.39.45
		V	
1,64		15	4.05.42
		15	4.21.30
		15	4.40.15
		V	
1,81			4.06.23 4.22.11 4.40.56
1,97		12	4.07.02
		12	4.22.50
		12	4.41.35
		V	
EROS			
2,10			4.07.41 4.23.29 4.42.14
RIACHO			
2,25			4.08.26 4.24.14 4.42.59
2,36		30	4.08.59
		27	4.24.47
		24	4.43.32
		V	
2,50		36	4.09.15
		33	4.25.05
		30	4.43.53
		V	
2,70			4.09.35 4.25.27 4.44.17
ESTRADAO			
2,74		5'	4.09.39
		5'	4.25.31
		5'	4.44.21
		N	
2,74		51	4.14.39
		48	4.30.31
		45	4.49.21
		V	
2,78			4.14.42 4.30.34 4.49.25

II Tamaranapag 33 de 34			
4,82			4.17.06 4.33.07 4.52.08
6,06			4.18.34 4.34.40 4.53.47
6,77			4.19.24 4.35.34 4.54.44
6,80			4.19.26 4.35.36 4.54.46
9,60		51	4.22.44
		48	4.39.06
		45	4.58.30
<b>0,00</b>		V	<b>V136</b>
PONTE			
2,58			4.25.46 4.42.19 5.01.57
ASFALTO			
3,10			4.26.22 4.42.58 5.02.38
TERRA			
3,68			4.27.03 4.43.42 5.03.25
6,27			4.30.06 4.46.56 5.06.52
PONTE			
7,77			4.31.52 4.48.49 5.08.52
9,15			4.33.29 4.50.32 5.10.42
10,78		10'	4.35.25
		10'	4.52.34
		10'	5.12.53
		D	

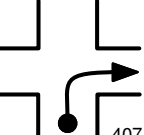
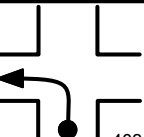
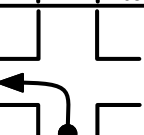
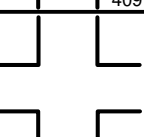
11,70			
11,78			
12,25			
12,35			
12,45		0'	4.45.25
		0'	5.02.34
		0'	5.22.53
		N	

**FIM DA PROVA !!**



Planilha gerada pelo programa TotemPlanilha que foi criado pela Totem.

Esta é uma das formas que a Totem participa da evolução do Off Road.

[www.totemonline.com.br](http://www.totemonline.com.br)

II Tamarana\_R1.pla /

275944B83DF4

v6.65